



**BONE SURGERY
INSTRUMENTS
BONE DRILL AND
PLATE INSTRUMENTS**



**Charriere Saw
Blade Only**
09-004-18 18cm
09-005-20 20cm
09-006-24 24cm

Charriere Bone Saw
09-001-18 18cm
09-002-20 20cm
09-003-24 24cm



**Satterlee Amputation
& Resection Saw**
09-007-31 31 cm



Satterlee Saw
09-008-30 30cm
Length of Blade 21.5cm



**Satterlee Saw
Blade Only**
09-009-21 21.5cm
09-010-23 23cm
09-011-25 25cm
Length Blade

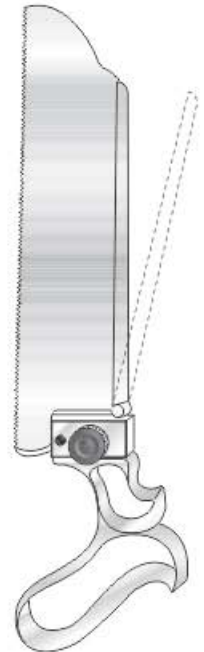

Satterlee Saw Hinged Back
09-012-23 23cm blade length
09-013-25 25cm blade length



Charriere Saw
09-014-28 28 cm
Spine Saw Double blade
with guide handle
Length of blades 16cm



Charriere Saw
09-015-35 35cm
Spare saw blades
09-016-01 12mm wide
09-017-02 18mm wide



**Charriere Bone Saw
Complete**
09-018-35 35.5cm



Helferich-Bier Saw
09-019-39 39cm
Spare saw blades
09-020-01 3mm wide
09-021-02 5mm wide
09-022-03 7mm wide
length of blade 27cm

AMPUTATING & RESECTION SAWS

amputations-und resektiosagen | sierra para amputacion y reseccion
Scies a amputation et resection | seghe per amputazione



Percy Amputation Shield
09-023-30 30.5cm
Handles Detachable



GIGLI
09-024-30 30cm
09-025-40 40cm
09-026-50 50cm
fine, 6 wires twisted



GIGLI
09-027-00
Handle



LEBSCHE
09-028-25
Conductor for wire saws, malleable
25cm



Joseph Bone Saw / Rasp
09-029-03 19cm



Linderman Amputation Saw
09-030-19 19cm



Linderman Amputation Saw
09-031-20 20cm



Langenbeck Metacarpal Saw
09-032-23 23cm
11.5cm Blade



Patella Bone Saw
09-033-00 Includes 1 blade
09-034-01 Replacement blade only
Delrin Handle

RASPS, FILES

Raspeln, Feilen
Rapes, Limes

Escofinas, limas
Raspe, lime



Putti Bone Rasp
09-035-27 27 cm
Double ended, One end curved up
one end curved sideways



Putti Rasp
09-036-30
30 cm
Double Ended



Bone File
09-037-28 28 cm
semicircular



Bone File
Bayonet Shape
09-038-24
24.5 cm
semicircular



Bone File
09-039-22 22 cm
flat



Fomon Rasp
09-040-01 21.5cm
Double Ended
one Sided straight
one side concave



Fomon Rasp
09-041-02 21.5cm
Double Ended
one Sided straight
one side convex



Fomon Rasp
09-042-03 21.5cm
Double Ended



Fomon Rasp
09-043-04 21.5cm
Double Ended straight
single Sided
one side concave



Fomon Rasp
09-044-05 21.5cm
Double Ended straight
single Sided
one side convex

RASPS, FILES

Raspeln, Feilen
Rapes, Limes

Escofinas, limas
Raspe, lime

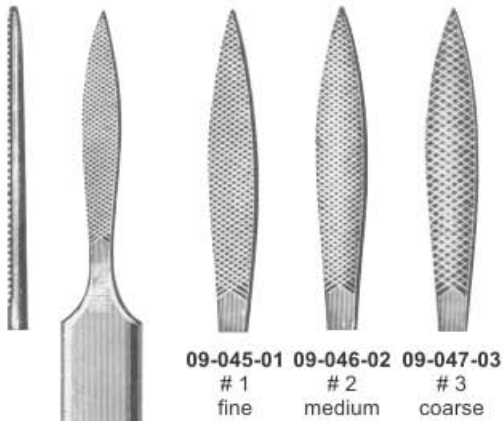

09-045-01 # 1 fine
09-046-02 # 2 medium
09-047-03 # 3 coarse

Joseph Bone and Nasal File
16cm
wide 8mm

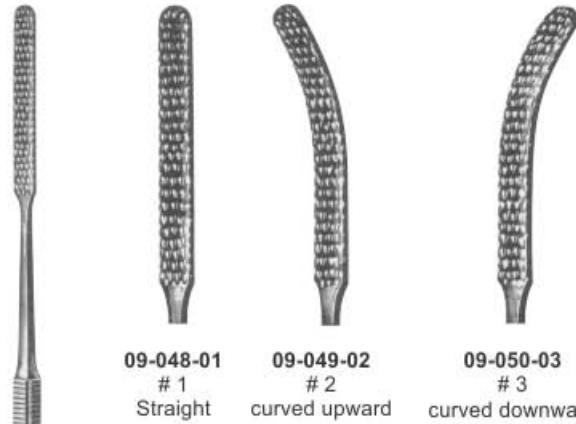

09-048-01 # 1 Straight
09-049-02 # 2 curved upward
09-050-03 # 3 curved downward

Gallaher Bone and Nasal Rasp, Coarse
18cm

Good Bone File / Rasp
09-051-16 16.5cm
Straight

KUMMAS
CORPORATION

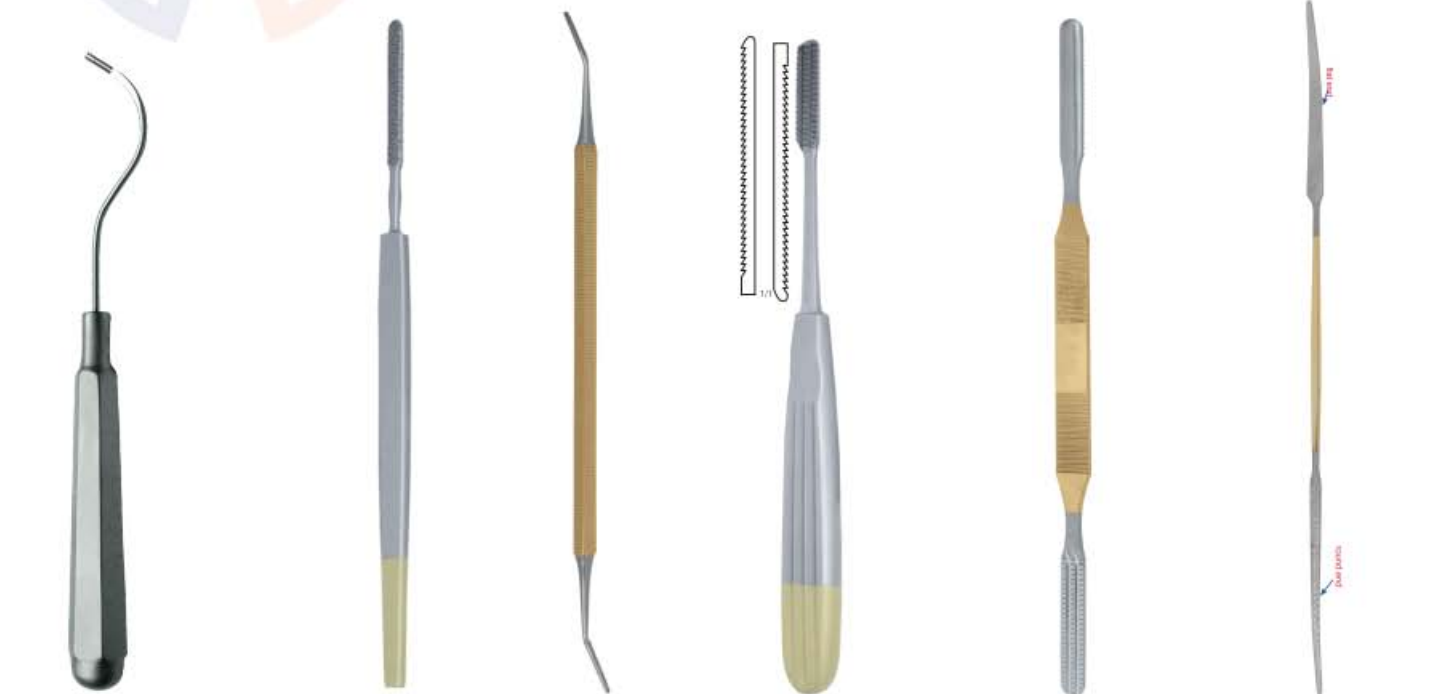

Kistler Ear Cartilage Rasp
09-052-01 left
09-053-02 right
16.5cm Curved

Micro Rasp
09-054-14 14cm
Single ended
double sided

Nail Rasp
09-055-17 17cm
Single sided

Maltz Rasp
09-056-18 18cm
Single-Ended
Single sided

Improved Maltz Rasp
09-057-18 18cm
Single-Sided
up & down rasping

Putti Rasp
09-058-23 23cm
falt / flat
09-059-30 30.5cm
Round / flat



Foman Rasp
09-060-21 21.5cm
Double ended, Fine & coarse serrations
4-sided convex and flat blades



Foman Rasp
09-061-21 21 cm



Kleinert-Kutz Bone Rasp
09-062-22 22.5cm
Double ended, Fine & coarse serrations



Miller Rasp
09-063-21 21.5cm
Double Ended straight single Sided



Miller-Colburn Bone File
18 cm
cross cut

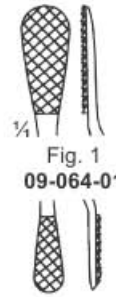

Fig. 1
09-064-01



Fig. 2
09-065-02

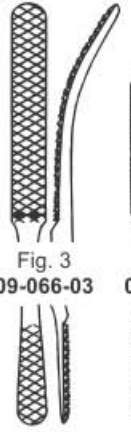
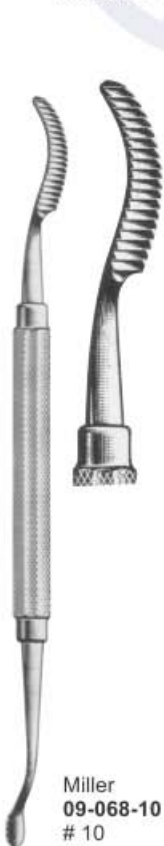

Fig. 3
09-066-03



Fig. 4
09-067-04



Miller
09-068-10
10

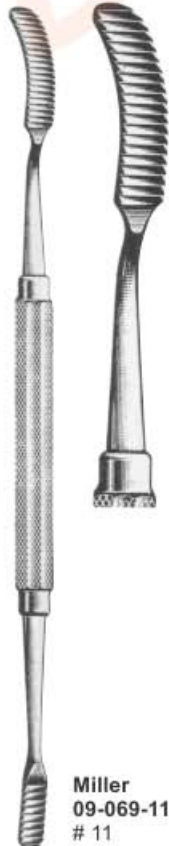

Miller
09-069-11
11

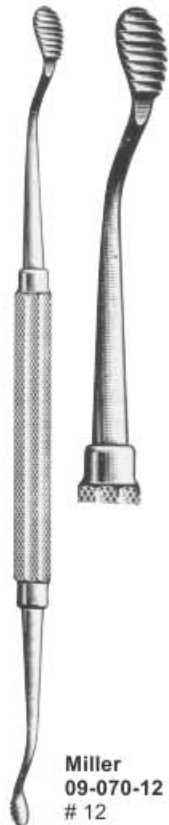

Miller
09-070-12
12

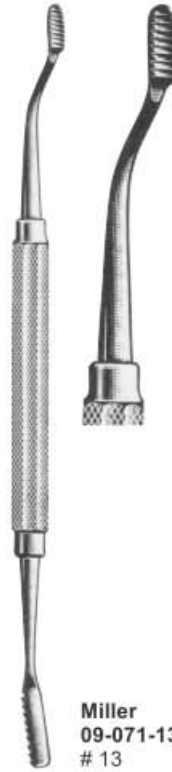

Miller
09-071-13
13

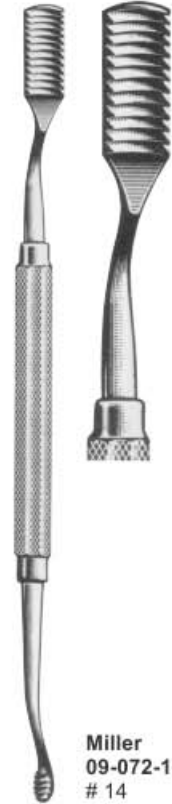

Miller
09-072-14
14

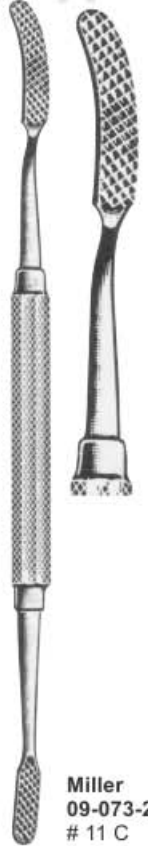

Miller
09-073-21
11 C

MALLETS

Hammer
Maillets

Martillos
Martelli



Doyen Mallets
25cm

09-074-25 25mmØ - 120g
09-075-30 30mmØ - 180g
09-076-35 35mmØ - 260g



Collin Mallets

09-077-20 20cm
30mmØ - 220g



Hajek Mallets

09-078-22 22cm
27mmØ - 140g



Kirk Mallets

09-079-38 20.5cm
38mmØ - 750g
09-080-39 20.5cm
38mmØ - 570g



Parsch Mallets

09-081-18 18cm
22mmØ - 200g



Lucae Mallets

09-082-19 19mmØ - 220g
09-083-25 25mmØ - 260g
19cm
Brass Solid



Mallet

09-084-25 19cm
25mmØ - 205g
Solid steel, with
plastic faces



Cottle Mallets

09-085-30 18.5cm
30mmØ - 240g
1 side flat /
1 side convex

MALLETS

Hammer
Maillets

Martillos
Martelli



Extra Nylon Face
09-089-01 2.54cmØ
09-090-02 3cmØ
09-091-03 3.2cmØ



Nylon Caps
09-093-01
2.5cm



Mallet
09-094-30 30 cm
head 16 oz.
(454 g) solid stainless



Mead Mallets
09-095-26 18cm
26mmØ - 320g
Steel solid, with
Plastic faces

Nylon Head Combination Mallet
09-086-25 25.4mmØ - 7.76 oz.
09-087-30 30mmØ - 11 oz.
09-088-32 32mmØ - 12 oz
19.5cm

Mallet, Lightweight
09-092-25 19cm
Stainless Steel and Aluminum
Head diameter 25mm
Weight 7 oz 200 grams
Head Weight: 4 oz 113 grams



Williger Mallets
09-096-20 16.5cm
20mmØ - 140g
lead filled



Williger Mallets
09-097-20 16.5cm
20mmØ - 140g
Brass Solid



Partsch Mallet
09-098-22 19.5cm
Head diameter 22mm
Weight 7 oz 200 grams
Head Weight: 5oz/150 grams
lead filled



Partsch Mallet
09-099-19 19cm
Head diameter 26mm
Weight 11 oz 315 grams
Head Weight: 6 oz 170 grams
lead filled



Solid Copper Head Mallet
09-100-20 16.5cm
Solid, 20mmØ

MALLETS

Hammer
Maillets

Martillos
Martelli



Gerzog Bone Mallet
09-101-25 19cm
Head diameter 25mm
Weight 10 oz (285 grams)
Head Weight: 7 oz (200 grams)



Bergmann Mallets
09-102-45 24.5cm
45mmØ - 300g



BERGMANN
09-103-30 300g
23cm



Ombredanne Mallets
09-104-40 24cm
40mmØ - 550g



Heath Mallets
09-105-40 18cm
40mmØ - 700g
09-106-45 20cm
45mmØ - 1000g
Lead filled



Orthopedic Mallet
09-107-50 28cm
Heavyweight
Solid, Head diameter 50.0mm
Head Weight: 2 lb. (900 grams)



Ortho Mallets
09-108-26 26.5 cm
(450g)



Williger Mallets
09-109-30 25mmØ - 300g
09-110-34 28mmØ - 340g
09-111-30 30mmØ - 400g
24cm Lead filled



09-112-23 350 g
Head made of
material used for implants
23cm



Mallet
09-113-24
24cm 400 g

MALLETS

Hammer
Maillets

Martillos
Martelli



Orthopaedic Mallet
09-114-19 19 cm



Mallet
09-115-00



Phenolic Handle Mallet
09-116-32 32mmØ
Head weight 16 oz (454 grams)
09-117-45 45mmØ
Weight 11 oz (312 grams);
Head weight: 2 lbs (907 grams),
28 cm



Repercussion Free Mallet
09-118-30 28cm
30mmØ
Weight 1lb 5 oz (595 grams)
Head weight: 10 oz (283 grams)



Nylon Cap
09-120-01
For Phenolic
Handle Mallet



Mallet
09-121-26 26 cm
Head 42/30mm Ø
weight 530 grams



Mallet
09-122-30 26 cm
Plastic Handle
head 30mm Ø
weight 510 grams



Vickers Mallets
09-123-25 19 cm
25mmØ - 300g
nylon disks plastic



Herbert Mallets
09-125-25 19 cm
25mmØ - 300g
for ulnar head
prosthesis plastic handle

MALLETS

Hammer
Maillets

Martillos
Martelli



Mallet
09-126-18 18 cm
Made of Plastic
Head 30mm Ø
weight 125 grams



Mallet
09-127-26 26 cm
Made of Plastic
with lead filling
Head 42mm Ø
weight 250 grams



Mallet
09-128-37 22.5 cm
Disks & Plastic Handle
Head 37mm Ø
weight 370 grams

Spare Facing (pair)
09-129-01 Plastic



Mallet
09-130-30 24 cm
Plastic Handle
Head 30mm Ø
weight 480 grams



Mallet
26 cm
Made of Plastic
with lead filling
09-131-42
Head 42 mm Ø
weight 400 grams
09-132-43
Head 42 mm Ø
weight 250 grams



Mallet
09-133-01



Mallet
09-134-01



09-135-35 Ø35mm
09-136-45 Ø45mm
09-137-50 Ø50mm
26cm

(sterilizable in autoclave
up to 143° C by 3 bar)



09-138-50
26cm
Ø50mm 400g

(sterilizable in autoclave
up to 143° C by 3 bar)

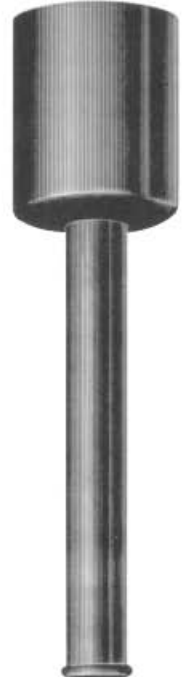

Steinbach
09-139-50
24cm
Ø50mm 400g

Ø50mm
400 g

Ø60mm
400 g



Chisel
13.5cm
09-140-08 8mm
09-141-10 10mm
09-142-12 12mm
09-143-14 14mm
09-144-16 16mm



Osteotome
13.5cm
09-145-08 8mm
09-146-10 10mm
09-147-12 12mm
09-148-14 14mm
09-149-16 16mm



Gouge
13.5cm
09-150-08 8mm
09-151-10 10mm
09-152-12 12mm
09-153-14 14mm
09-154-16 16mm



Lucas Chisel
16cm
09-155-03 3mm
09-156-04 4mm
09-157-05 5mm
09-158-06 6mm



Lucas Gouge
16cm
09-159-03 3mm
09-160-04 4mm
09-161-05 5mm
09-162-06 6mm



Alexander Chisel 18cm
09-163-04 4mm
09-164-06 6mm
09-165-08 8mm
09-166-10 10mm
09-167-12 12mm
09-168-14 14mm



Alexander Gouge 18cm
09-169-04 4mm
09-170-06 6mm
09-171-08 8mm
09-172-10 10mm
09-173-12 12mm
09-174-14 14mm



Partsch Chisel 11.5cm
09-175-02 2mm
09-176-03 3mm
09-177-04 4mm
09-178-06 6mm
09-179-07 7mm
09-180-08 8mm

Partsch Chisel 17.5cm
09-187-02 2mm
09-188-03 3mm
09-189-04 4mm
09-190-06 6mm
09-191-07 7mm
09-192-08 8mm



Partsch Osteotome 11.5cm
09-193-02 2mm
09-194-03 3mm
09-195-04 4mm
09-196-06 6mm
09-197-07 7mm
09-198-08 8mm

Partsch Osteotome 17.5cm
09-205-02 2mm
09-206-03 3mm
09-207-04 4mm
09-208-06 6mm
09-209-07 7mm
09-210-08 8mm



Partsch Gouge 11.5cm
09-211-02 2mm
09-212-03 3mm
09-213-04 4mm
09-214-06 6mm
09-215-07 7mm
09-216-08 8mm

Partsch Gouge 17.5cm
09-217-02 2mm
09-218-03 3mm
09-219-04 4mm
09-220-06 6mm
09-221-07 7mm
09-222-08 8mm

BONE CHISELS, GOUGES, OSTEOTOME

Knochenmeißel, Meißel, Osteotome | *Cinceles óseos, gubias, osteótomos*
Ciseaux à os, gouges, ostéotomes | *ScalPELLI per ossa, sgorbie, osteotomi*



U.S. Army Chisels

09-229-06 6mm
 09-230-12 12mm
 09-231-18 18mm
 16cm

U.S. Army Osteotomes

09-232-06 6mm
 09-233-12 12mm
 09-234-18 18mm
 16cm

U.S. Army Gouges

09-235-06 6mm
 09-236-12 12mm
 09-237-18 18mm
 16cm

Schwartz Chisels

09-238-02 2mm
 09-239-04 4mm
 09-240-06 6mm
 09-241-08 8mm
 09-242-10 10mm
 11cm

Schwartz Gouges

09-243-02 2mm
 09-244-04 4mm
 09-245-06 6mm
 09-246-08 8mm
 09-247-10 10mm
 11cm

Trautmann Chisels

09-248-02 2mm
 09-249-04 4mm
 09-250-06 6mm
 09-251-08 8mm
 09-252-10 10mm
 11cm



Trautmann Gouges

09-253-02 2mm
 09-254-04 4mm
 09-255-06 6mm
 09-256-08 8mm
 09-257-10 10mm
 11cm



Bishop Chisels

09-258-02 2mm
 09-259-03 3mm
 09-260-04 4mm
 09-261-05 5mm
 09-262-06 6mm
 09-263-08 8mm
 15cm



Bishop Gouges

09-264-02 2mm
 09-265-03 3mm
 09-266-04 4mm
 09-267-05 5mm
 09-268-06 6mm
 15cm



Bishop Chisels

09-269-03 3mm
 09-270-04 4mm
 09-271-05 5mm
 17cm



Bishop Gouges

09-272-03 3mm
 09-273-04 4mm
 09-274-05 5mm
 17cm

BONE CHISELS, GOUGES, OSTEOTOME

Knochenmeißel, Meißel, Osteotome | *Cinceles óseos, gubias, osteótomos*
Ciseaux à os, gouges, ostéotomes | *Scalpelli per ossa, sgorbie, osteotomi*



Stille
20cm



Stille Chisel
 09-275-10 10mm
 09-276-15 15mm
 09-277-20 20mm
 09-278-25 25mm
 Straight



Stille Osteotome
 09-279-04 4mm
 09-280-06 6mm
 09-281-08 8mm
 09-282-10 10mm
 09-283-12 12mm
 09-284-15 15mm
 09-285-20 20mm
 09-286-25 25mm
 Straight



Stille Osteotome
 09-287-10 10mm
 09-288-15 15mm
 09-289-20 20mm
 09-290-25 25mm
 Curved



Stille Gouge
 09-291-08 8mm
 09-292-10 10mm
 09-293-12 12mm
 09-294-15 15mm
 09-295-20 20mm
 09-296-25 25mm
 Straight



Stille Gouge
 09-297-10 10mm
 09-298-15 15mm
 09-299-20 20mm
 09-300-25 25mm
 Curved

KUMMAS
CORPORATION



Smith-Petersen
20cm



Smith-Petersen Osteotome
 09-301-06 6mm
 09-302-09 9mm
 09-303-13 13mm
 09-304-16 16mm
 09-305-19 19mm
 09-306-25 25mm
 09-307-30 30mm
 Straight



Smith-Petersen Osteotome
 09-308-06 6mm
 09-309-09 9mm
 09-310-13 13mm
 09-311-16 16mm
 09-312-19 19mm
 09-313-25 25mm
 09-314-30 30mm
 Curved



Smith-Petersen Gouge
 09-315-06 6mm
 09-316-09 9mm
 09-317-13 13mm
 09-318-16 16mm
 09-319-19 19mm
 09-320-25 25mm
 09-321-30 30mm
 Straight



Smith-Petersen Gouge
 09-322-06 6mm
 09-323-09 9mm
 09-324-13 13mm
 09-325-16 16mm
 09-326-19 19mm
 09-327-25 25mm
 09-328-30 30mm
 Curved

BONE CHISELS, GOUGES, OSTEOTOME

Knochenmeißel, Meißel, Osteotome | *Cinceles óseos, gubias, osteótomos*
Ciseaux à os, gouges, ostéotomes | *ScalPELLI per ossa, sgorbie, osteotomi*



Hibbs
24cm

Hibbs Chisel
 09-329-06 6mm
 09-330-13 13mm
 09-331-19 19mm
 09-332-25 25mm
 09-333-32 32mm
 Straight



Hibbs Osteotome
 09-334-06 6mm
 09-335-13 13mm
 09-336-19 19mm
 09-337-25 25mm
 09-338-32 32mm
 Straight



Hibbs Osteotome
 09-339-06 6mm
 09-340-13 13mm
 09-341-19 19mm
 09-342-25 25mm
 09-343-32 32mm
 Curved



Hibbs Gouge
 09-344-06 6mm
 09-345-13 13mm
 09-346-19 19mm
 09-347-25 25mm
 09-348-32 32mm
 Straight



Hibbs Gouge
 09-349-06 6mm
 09-350-13 13mm
 09-351-19 19mm
 09-352-25 25mm
 09-353-32 32mm
 Curved



Hoke Osteotome
 17cm
 09-354-03 3mm
 09-355-05 5mm
 09-356-07 7mm
 09-357-08 8.5mm
 09-358-10 10mm
 09-359-12 12mm
 Straight



Hoke Osteotome
 17cm
 09-360-03 3mm
 09-361-05 5mm
 09-362-07 7mm
 09-363-08 8.5mm
 09-364-10 10mm
 09-365-12 12mm
 Curved



**Obwegeser
Blade Osteotome**
 09-366-07 7mm
 21.5cm



**Obwegeser
Blade Osteotome**
 09-367-10 10mm
 21.5cm



Obwegeser Osteotome
 09-368-11 23.5cm
 11mm

BONE CHISELS, GOUGES, OSTEOTOME

Knochenmeißel, Meißel, Osteotome | *Cinceles óseos, gubias, osteótomos*
Ciseaux à os, gouges, ostéotomes | *ScalPELLi per ossa, sgorbie, osteotomi*



Hibbs Chisel

22.5 cm straight
09-369-06 6 mm
09-370-09 9 mm
09-371-12 12 mm
09-372-15 15 mm
09-373-18 18 mm
09-374-20 20 mm
09-375-25 25 mm
09-376-30 30 mm
09-377-35 35 mm
09-378-40 40 mm



22.5 cm curved
09-379-06 6 mm
09-380-09 9 mm
09-381-12 12 mm
09-382-15 15 mm
09-383-18 18 mm
09-384-20 20 mm
09-385-25 25 mm
09-386-30 30 mm
09-387-35 35 mm
09-388-40 40 mm



Osteotomes

22.5 cm straight
09-389-06 6 mm
09-390-09 9 mm
09-391-12 12 mm
09-392-15 15 mm
09-393-18 18 mm
09-394-20 20 mm
09-395-25 25 mm
09-396-30 30 mm
09-397-35 35 mm
09-398-40 40 mm



22.5 cm curved
09-399-06 6 mm
09-400-09 9 mm
09-401-12 12 mm
09-402-15 15 mm
09-403-18 18 mm
09-404-20 20 mm
09-405-25 25 mm
09-406-30 30 mm
09-407-35 35 mm
09-408-40 40 mm

Hibbs Chisel

Hibbs Osteotomes

KUMMAS
CORPORATION



Cobb Chisel

27.5 cm straight
09-409-06 6 mm
09-410-09 9 mm
09-411-12 12 mm
09-412-15 15 mm
09-413-18 18 mm
09-414-25 25 mm
09-415-35 35 mm



27.5 cm Curved
09-416-06 6 mm
09-417-09 9 mm
09-418-12 12 mm
09-419-15 15 mm
09-420-18 18 mm
09-421-25 25 mm
09-422-35 35 mm



Osteotomes

27.5 cm Straight
09-423-06 6 mm
09-424-09 9 mm
09-425-12 12 mm
09-426-15 15 mm
09-427-18 18 mm
09-428-25 25 mm
09-429-35 35 mm



27.5 cm curved
09-430-06 6 mm
09-431-09 9 mm
09-432-12 12 mm
09-433-15 15 mm
09-434-18 18 mm
09-435-25 25 mm
09-436-35 35 mm

Cobb Chisel

Cobb Osteotomes



Cobb Gouge
24 cm



09-437-01
Straight



09-438-02
Slightly Curved



09-439-03
Strongly Curved



09-440-04
Curved down



09-441-01
Straight



09-442-02
Slightly Curved



09-443-03
Strongly Curved



09-444-04
Curved down



Hibbs Gouge Endoscopic.
09-445-46 46 cm
7 mm tip width straight, graduated



Hibbs Chisel Endoscopic
09-446-01 46 cm
10 mm tip width straight

Hibbs Osteotomes Endoscopic
09-447-02 46 cm
10 mm tip width straight

Cobb Gouge
24 cm
Knurled Handle

Tuffnel Handle



- Lexer Chisel**
 22 cm
 09-448-07 7 mm
 09-449-10 10 mm
 09-450-12 12 mm
 09-451-15 15 mm
 09-452-20 20 mm
 09-453-25 25 mm
 09-454-30 30 mm
Lexer Modif. Chisel
 29 cm
 09-455-07 7 mm
 09-456-10 10 mm
 09-457-12 12 mm
 09-458-15 15 mm
 09-459-20 20 mm
 09-460-25 25 mm
 09-461-30 30 mm



- Lexer Osteotome**
 22 cm
 09-462-07 7 mm
 09-463-10 10 mm
 09-464-12 12 mm
 09-465-15 15 mm
 09-466-20 20 mm
 09-467-25 25 mm
 09-468-30 30 mm
Lexer Modif. Osteotome
 29 cm
 09-469-07 7 mm
 09-470-10 10 mm
 09-471-12 12 mm
 09-472-15 15 mm
 09-473-20 20 mm
 09-474-25 25 mm
 09-475-30 30 mm



- Lexer Gouge**
 22 cm
 09-476-10 10 mm
 09-477-15 15 mm
 09-478-20 20 mm
 09-479-25 25 mm
Lexer Gouge Modif.
 29 cm
 09-480-10 10 mm
 09-481-15 15 mm
 09-482-20 20 mm
 09-483-25 25 mm



- Mini Lexer Chisel**
 09-484-02 2mm
 09-485-04 4mm
 09-486-06 6mm
 09-487-08 8mm
 09-488-10 10mm
 09-489-12 12mm
 09-490-15 15mm
 09-491-20 20mm
 18cm



- Mini Lexer Osteotome**
 09-492-02 2mm
 09-493-04 4mm
 09-494-06 6mm
 09-495-08 8mm
 09-496-10 10mm
 09-497-12 12mm
 09-498-15 15mm
 09-499-20 20mm
 18cm



- Lexer Gouge**
 25 mm
 09-500-05 5 mm
 09-501-10 10 mm
 09-502-15 15 mm
 Straight



- Lexer Gouge**
 25 mm
 09-503-05 5 mm
 09-504-10 10 mm
 09-505-15 15 mm
 Curved

Tuffnel Handle



Capener Chisels
25cm
09-506-06 6mm
09-507-08 8mm
09-508-10 10mm
09-509-12 12mm
09-510-15 15mm
09-511-20 20mm
09-512-25 25mm
09-513-30 30mm
 Straight



Capener Chisels
25cm
09-514-06 6mm
09-515-08 8mm
09-516-10 10mm
09-517-12 12mm
09-518-15 15mm
09-519-20 20mm
09-520-25 25mm
09-521-30 30mm
 Curved



Capener Osteotome
25cm
09-522-10 10mm
09-523-12 12mm
09-524-15 15mm
09-525-20 20mm
09-526-25 25mm
09-527-30 30mm
 Straight



Capener Osteotome
25cm
09-528-10 10mm
09-529-12 12mm
09-530-15 15mm
09-531-20 20mm
09-532-25 25mm
09-533-30 30mm
 Curved



Zielke
09-534-05 5.5mm
09-535-09 9.0mm
 23cm

Gouges for scoliosis operations



Cobb Spinal Gouge
09-536-01
 4mm, 28cm
 Straight



Cobb Spinal Gouge
09-537-02
 4mm, 28cm
 Light curve



Cobb Spinal Gouge
09-538-03
 4mm, 28cm
 strong curve



Cobb Spinal Gouge
09-539-04
 4mm, 28cm
 curved to rear



Chisel
09-540-11
 115mm/280mm
 for extraction
 of cement



Chisel
09-541-09
 for extraction
 of cement 9mm
 Positive 400mm



Chisel
09-542-01
 with 2 prong

OSTEOTOME

Osteotom | osteótomo
Ostéotome | Osteotomo



Lambotte Osteotome
25cm

- 09-543-06 6mm
- 09-544-08 8mm
- 09-545-10 10mm
- 09-546-13 13mm
- 09-547-14 15mm
- 09-548-20 20mm
- 09-549-25 25mm
- 09-550-30 30mm
- 09-551-38 38mm
- 09-552-44 44mm
- 09-553-50 50mm
- Straight

Lambotte Osteotome
25cm

- 09-554-06 6mm
- 09-555-08 8mm
- 09-556-10 10mm
- 09-557-13 13mm
- 09-558-15 15mm
- 09-559-20 20mm
- 09-560-25 25mm
- 09-561-30 30mm
- 09-562-38 38mm
- 09-563-44 44mm
- 09-564-50 50mm
- Curved

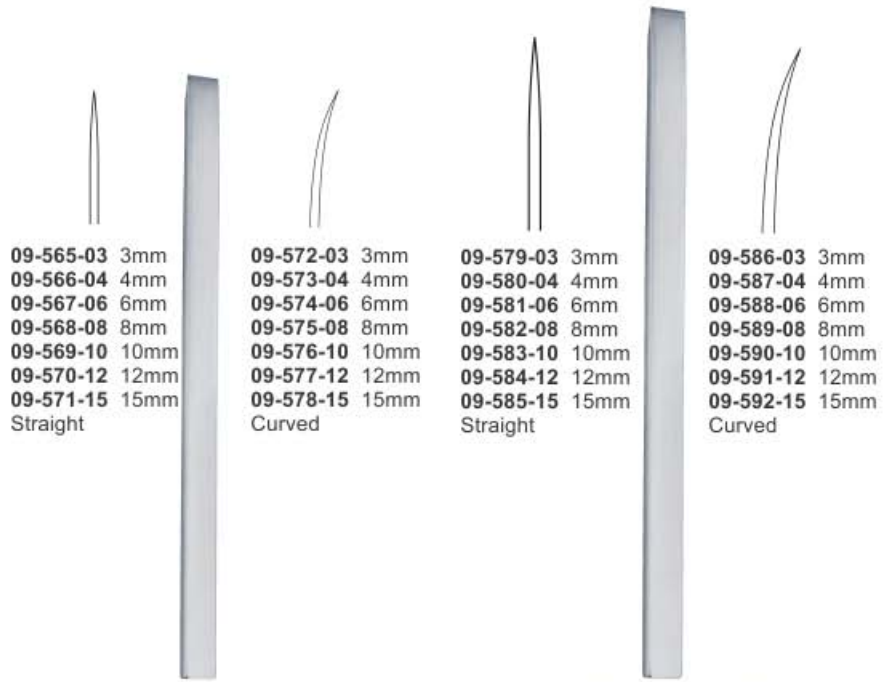

- 09-565-03 3mm
- 09-566-04 4mm
- 09-567-06 6mm
- 09-568-08 8mm
- 09-569-10 10mm
- 09-570-12 12mm
- 09-571-15 15mm
- Straight

- 09-572-03 3mm
- 09-573-04 4mm
- 09-574-06 6mm
- 09-575-08 8mm
- 09-576-10 10mm
- 09-577-12 12mm
- 09-578-15 15mm
- Curved

- 09-579-03 3mm
- 09-580-04 4mm
- 09-581-06 6mm
- 09-582-08 8mm
- 09-583-10 10mm
- 09-584-12 12mm
- 09-585-15 15mm
- Straight

- 09-586-03 3mm
- 09-587-04 4mm
- 09-588-06 6mm
- 09-589-08 8mm
- 09-590-10 10mm
- 09-591-12 12mm
- 09-592-15 15mm
- Curved

Mini-Lambotte Osteotome
12.5cm

Mini-Lambotte Osteotome
17cm

KUMMAS
CORPORATION



Cottle Osteotome

- 18.5cm Straight
- 09-593-04 4mm tip width
- 09-594-06 6mm tip width
- 09-595-09 9mm tip width
- 09-596-12 12mm tip width

Anderson-Nievert Osteotome
20.5cm

- 09-597-01 Curved right
- 09-598-02 Curved left
- 09-599-03 Straight

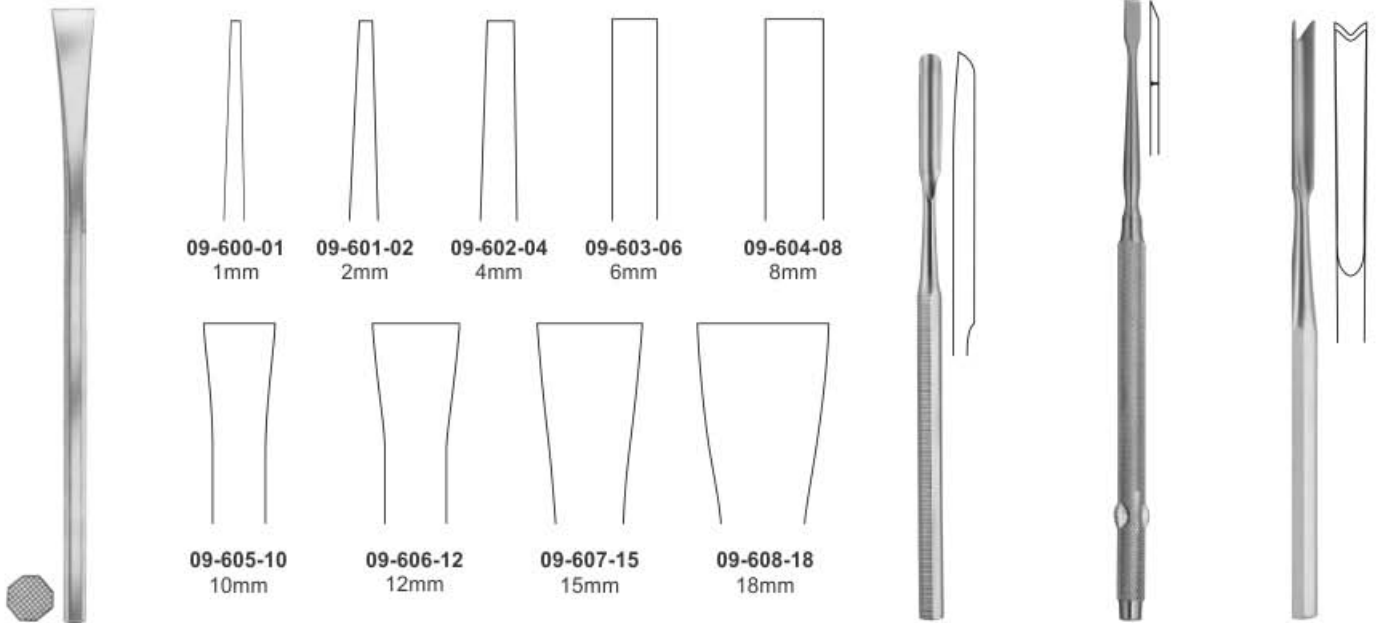

Sheehan osteotome
16cm
for delicate bone cutting in
plastic and hand surgery

Freer Gouge
09-609-15
15cm
06mm

Freer Chisel
09-610-16
16cm
04mm

Ballenger Chisel
09-611-04 4mm
09-612-06 6mm
09-613-08 8mm
16cm

KUMMAS
CORPORATION



Shoulder Penetrating Gouge
09-614-21
21.6cm
Straight, 3mm distal tip

Mannerfelt Modif.

Osteotomes
09-615-04 4mm
09-616-06 6mm
09-617-08 8mm
15.5cm

Gouge
09-618-04
4mm
15.5cm

Kilian, Septum Gouge
09-619-16 16cm
5mm

Kilian-Claus Septum Gouge
09-620-16 16cm
5mm

Cottle Osteotome
09-621-07 7mm
09-622-12 12mm
15cm

Cottle Osteotome
09-623-19 19cm
4mm

Cottle Osteotome with depth markings
09-624-18 18cm
6mm

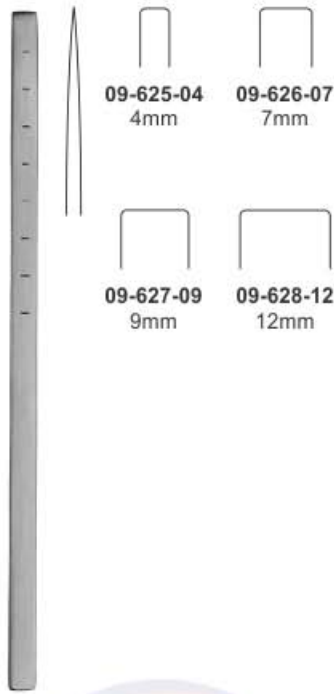

Cottle Osteotome
18cm

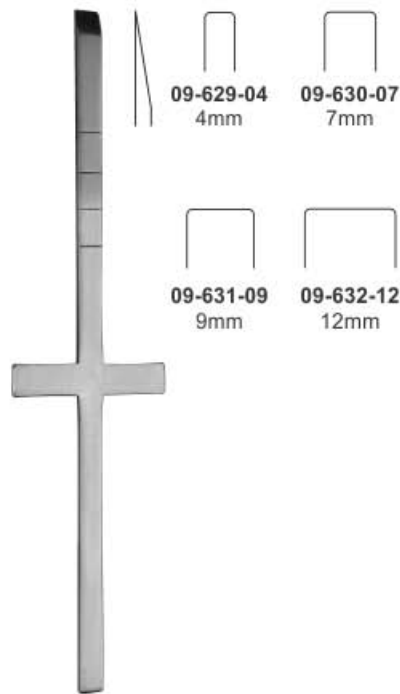

Cottle Chisel
18cm

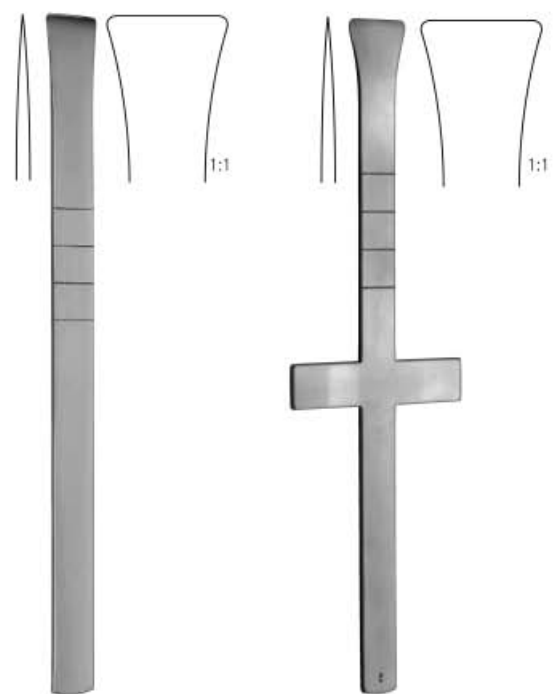

Cottle Osteotomes
09-633-16 18cm
16mm Protected
and depth markings

Cottle Osteotomes
09-634-16 18cm
16mm Cross bar
and depth markings



Cottle Osteotomes
09-635-06 18cm
06mm Cross bar
and depth markings

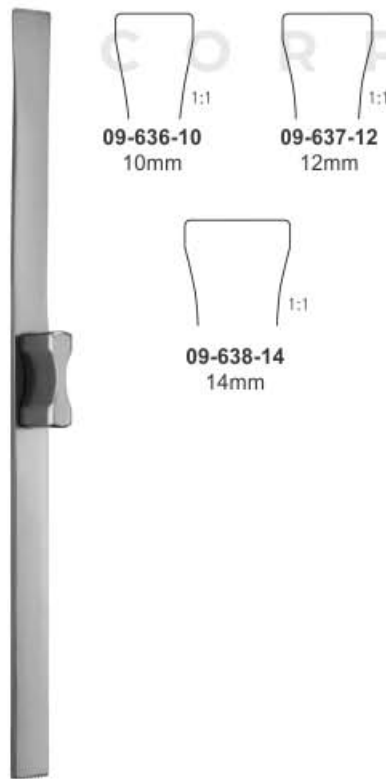

Rubin osteotome
with stabilizer to reduce
chance of twisting for
more control
18cm

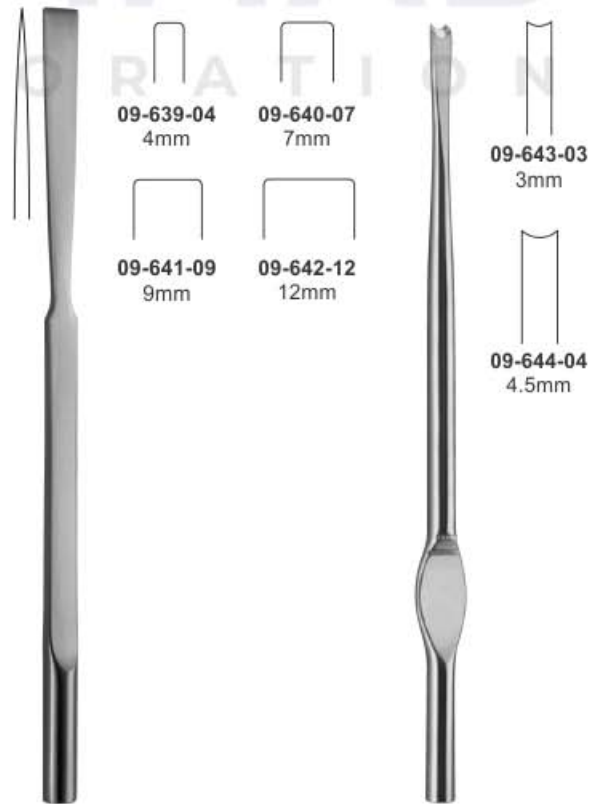

Cottle Osteotome
20cm

Walter Gouge
19cm

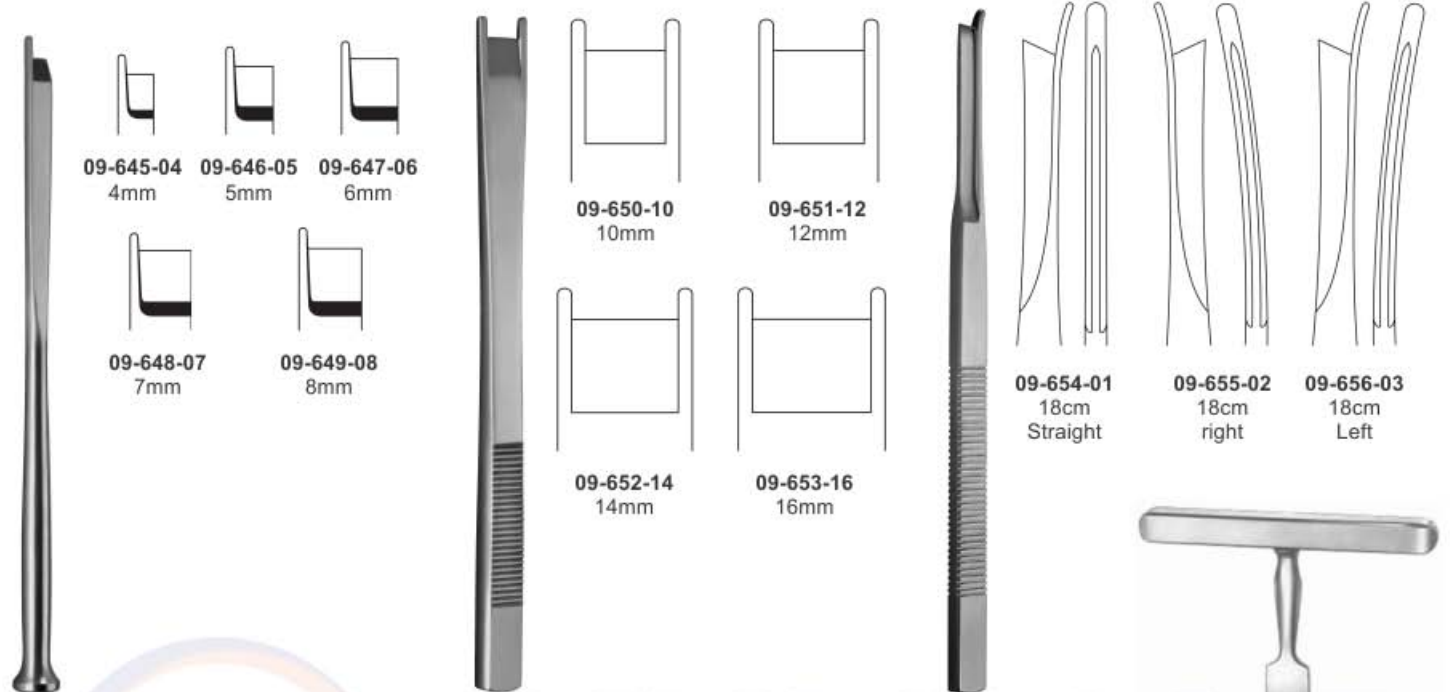

Fomon Chisel
17cm

Cinelli Chisel
18cm

Silver Rhinoplastic Chisel

Virchow
09-657-00



Neivert-Anderson osteotome

Brunetti
09-661-15
28cm

Brunetti
09-662-15
28cm

Rhachiotomes
09-663-22
22cm

Rhachiotomes
09-664-16
16cm



Chisel Blade Handle
35-300-00 18.5cm

Chisel blades, interchangeable



09-665-01 8.5cm
5mm



09-666-02 8.5cm
10mm



09-667-03 8.5cm
16mm



09-668-04 8.5cm
25mm

KUMMAS
CORPORATION

Osteotome blades, interchangeable



09-669-05 8.5cm
5mm



09-670-06 8.5cm
10mm



09-671-07 8.5cm
16mm



09-672-08 8.5cm
25mm



Chisel Blade key
09-673-09 9cm



Bone Tamper

- | | | |
|---|---|--|
| ○
09-674-02
15.5cm
Head diameter
2mm | ○
09-675-03
15.5cm
Head diameter
3mm | ○
09-676-04
15.5cm
Head diameter
4mm |
| | ○
09-677-05
15.5cm
Head diameter
5mm | ○
09-678-06
15.5cm
Head diameter
6mm |
| | ○
09-679-08
15.5cm
Head diameter
8mm | ○
09-680-10
15.5cm
Head diameter
10mm |



**Passow
Bone Tamper**
12cm

- | |
|--|
| □
09-681-25
2.5mm x 2.5mm |
| □
09-682-35
3.5mm x 3.5mm |



Bone Tamps
15.4 cm



- Tip Size
- 09-683-02** 2 mm
 - 09-684-03** 3 mm
 - 09-685-04** 4 mm
 - 09-686-05** 5 mm
 - 09-687-06** 6 mm
 - 09-688-08** 8 mm
 - 09-689-10** 10 mm

KUMMAS
CORPORATION



**Caspar
Bone Tamper**
20cm

- | | |
|------------------------------|------------------------------|
| ●
09-690-03
3mm | ●
09-691-05
5mm |
| ●
09-692-08
8mm | |



**Caspar
Bone Tamper**
20cm

- | | |
|-------------------------------|-------------------------------|
| ●
09-693-12
12mm | ●
09-694-14
14mm |
| ●
09-695-16
16mm | |



Meyhoefer
14cm

- | | | |
|--|--|--|
| ●
09-696-01
Fig. 0
Ø2 mm | ●
09-697-02
Fig. 1
Ø2.5 mm | ●
09-698-03
Fig. 2
Ø3 mm |
| ●
09-699-04
Fig. 3
Ø3.5 mm | ●
09-700-05
Fig. 4
Ø5 mm | |

BONE CURETTES

Scharfe Löffel

cucharillas cortantes

Curettes tranchantes

Cucchiai taglianti

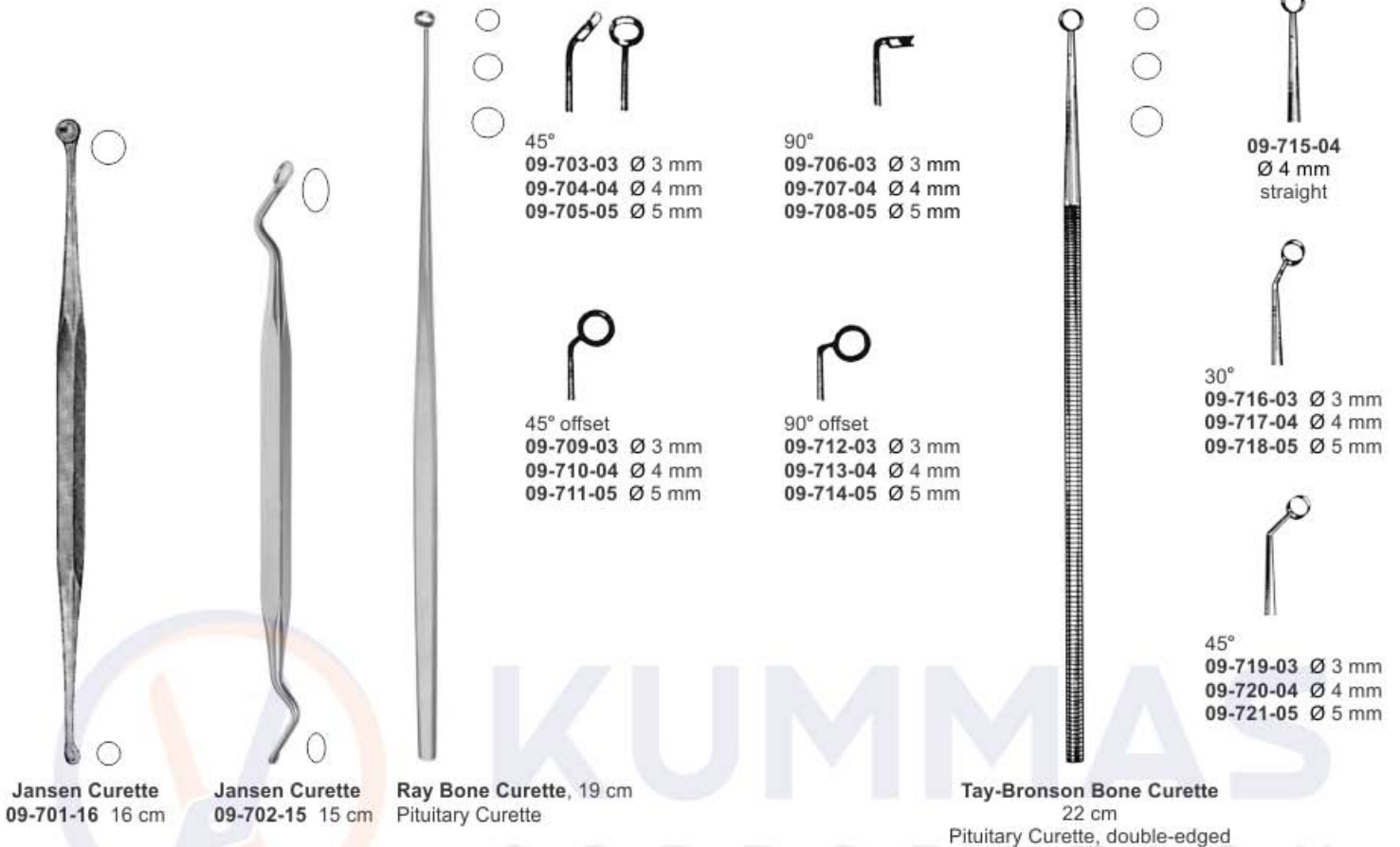

Jansen Curette
09-701-16 16 cm

Jansen Curette
09-702-15 15 cm

Ray Bone Curette, 19 cm
Pituitary Curette

45°
09-703-03 Ø 3 mm
09-704-04 Ø 4 mm
09-705-05 Ø 5 mm

90°
09-706-03 Ø 3 mm
09-707-04 Ø 4 mm
09-708-05 Ø 5 mm

45° offset
09-709-03 Ø 3 mm
09-710-04 Ø 4 mm
09-711-05 Ø 5 mm

90° offset
09-712-03 Ø 3 mm
09-713-04 Ø 4 mm
09-714-05 Ø 5 mm

09-715-04
Ø 4 mm
straight

30°
09-716-03 Ø 3 mm
09-717-04 Ø 4 mm
09-718-05 Ø 5 mm

45°
09-719-03 Ø 3 mm
09-720-04 Ø 4 mm
09-721-05 Ø 5 mm

Tay-Bronson Bone Curette
22 cm
Pituitary Curette, double-edged

KUMMAS CORPORATION

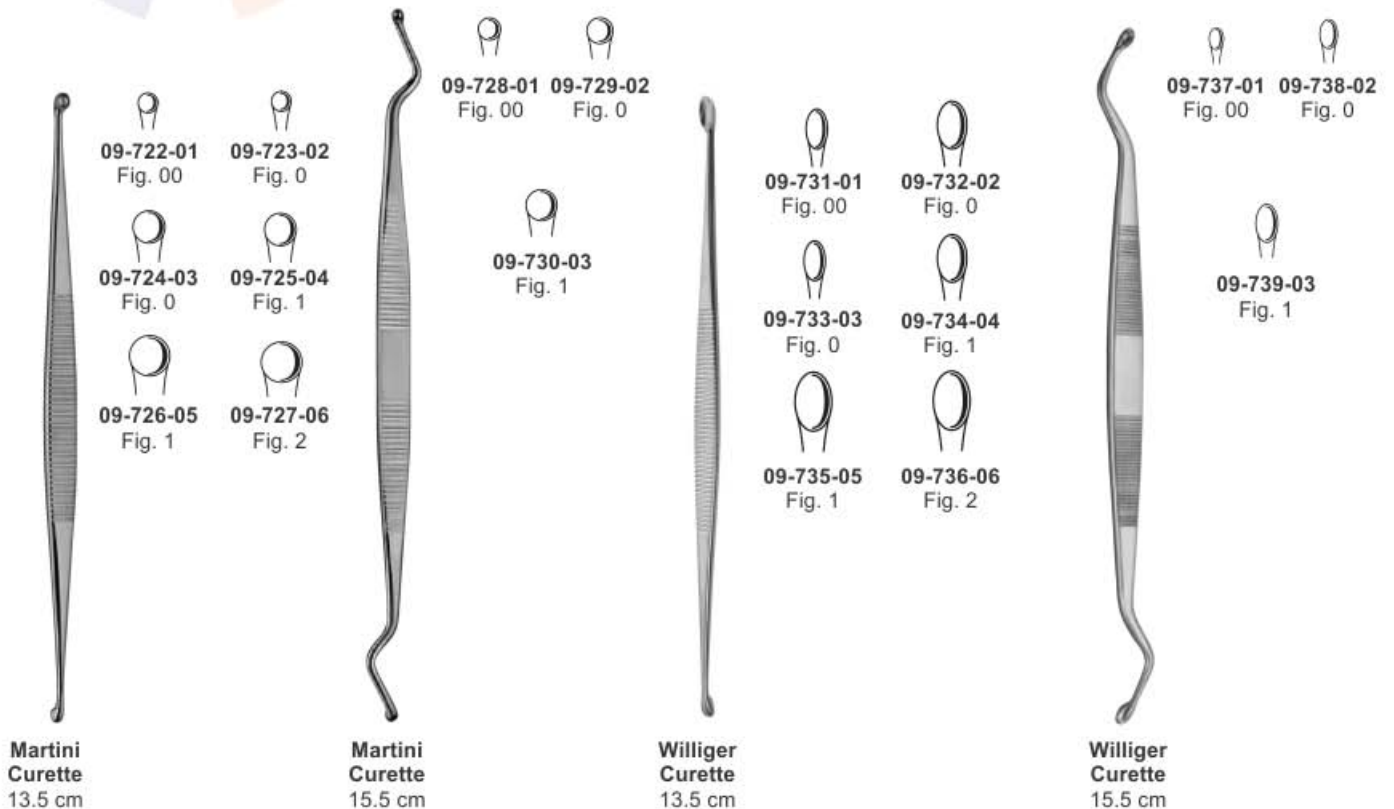

Martini Curette
13.5 cm

Martini Curette
15.5 cm

Williger Curette
13.5 cm

Williger Curette
15.5 cm

09-722-01 Fig. 00 09-723-02 Fig. 0
09-724-03 Fig. 0 09-725-04 Fig. 1
09-726-05 Fig. 1 09-727-06 Fig. 2

09-728-01 Fig. 00 09-729-02 Fig. 0
09-730-03 Fig. 1

09-731-01 Fig. 00 09-732-02 Fig. 0
09-733-03 Fig. 0 09-734-04 Fig. 1
09-735-05 Fig. 1 09-736-06 Fig. 2

09-737-01 Fig. 00 09-738-02 Fig. 0
09-739-03 Fig. 1

BONE CURETTES

Scharfe Löffel

cucharillas cortantes

Curettes tranchantes

Cucchiai taglianti

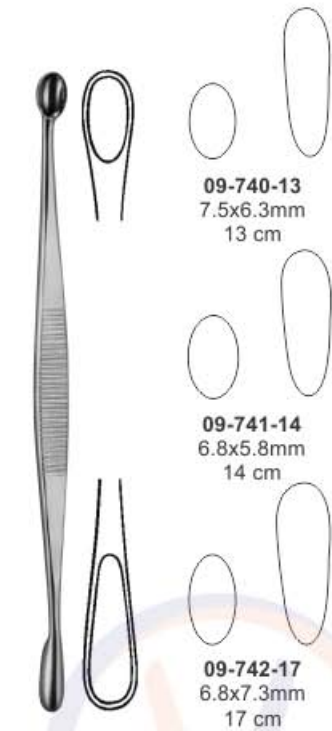

09-740-13
7.5x6.3mm
13 cm

09-741-14
6.8x5.8mm
14 cm

09-742-17
6.8x7.3mm
17 cm

**Volkman
Curette**
Oval / Oval

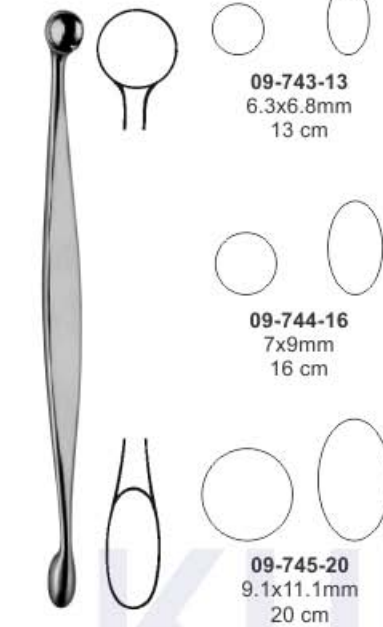

09-743-13
6.3x6.8mm
13 cm

09-744-16
7x9mm
16 cm

09-745-20
9.1x11.1mm
20 cm

**Volkman
Curette**
Round / Oval



**Curette
09-746-21**
21cm
round / oval

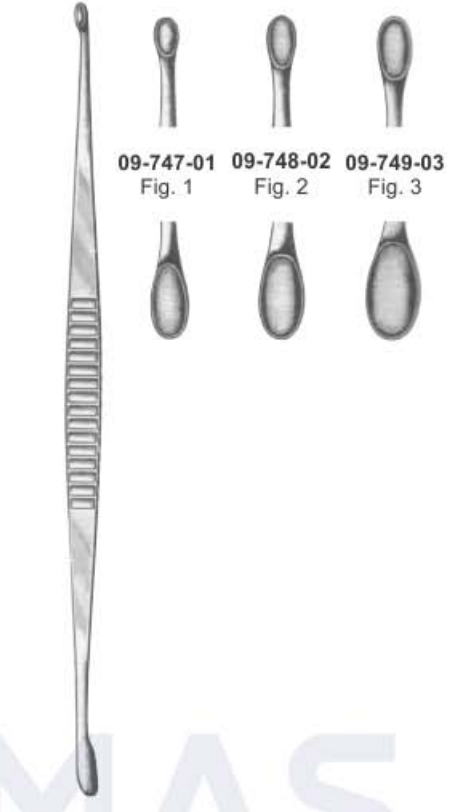

09-747-01
Fig. 1

09-748-02
Fig. 2

09-749-03
Fig. 3

**Volkman Bone Curettes
double-ended, oval**
22cm 8 3/4"

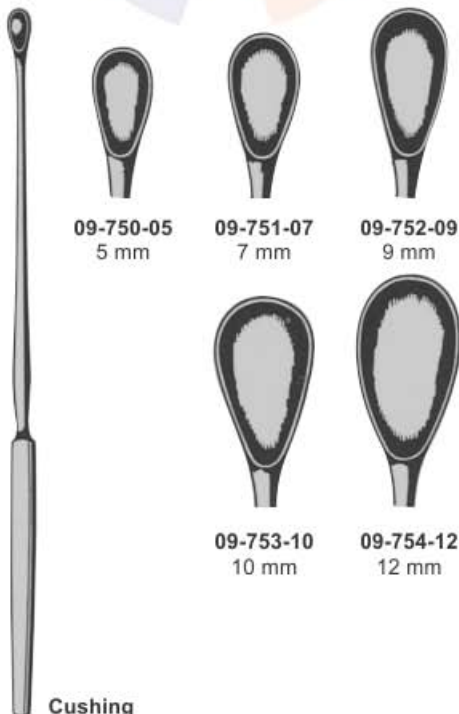

09-750-05
5 mm

09-751-07
7 mm

09-752-09
9 mm

09-753-10
10 mm

09-754-12
12 mm

**Cushing
Bone Curette**
23.5 cm
Pituitary Spoon,
malleable, silver-plated

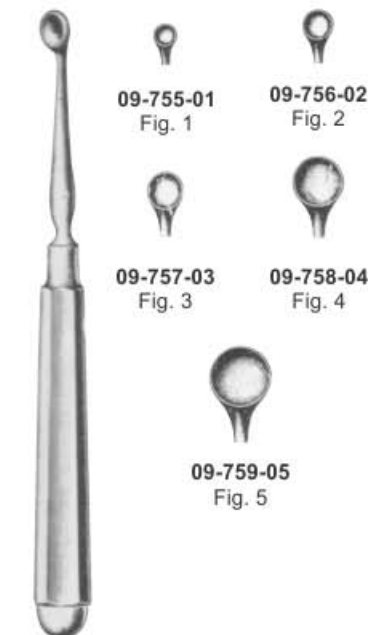

09-755-01
Fig. 1

09-756-02
Fig. 2

09-757-03
Fig. 3

09-758-04
Fig. 4

09-759-05
Fig. 5

**Buck Bone
Curettes**
14.5cm



09-760-01
Fig. 1
Ø4mm

09-761-02
Fig. 2
Ø5mm

**Williger
Bone Curettes**
17cm



09-762-01
Fig. 1
3,5mm

09-763-02
Fig. 2
5,5mm

**Williger
Bone Curettes**
17cm

BONE CURETTES

Scharfe Löffel
Curettes tranchantes

cucharillas cortantes
Cucchiai taglianti

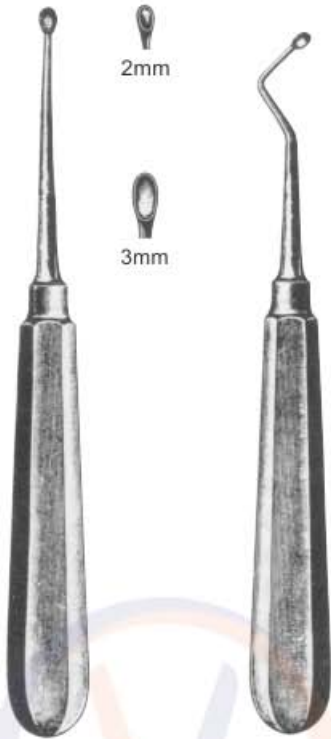

09-764-02 2mm
09-765-03 3mm
15cm
Kerpel

09-766-02 2mm
09-767-03 3mm
15cm
Kerpel
angled to right



09-768-02 2mm
09-769-03 3mm
15cm
Kerpel
angled to left













**Uffenorde Bone
Curette Left**
09-770-01
17.5 cm



**Uffenorde Bone
Curette Right**
09-771-02
17.5 cm













Bone Curettes, round,
Swedish Pattern
17 - 20cm

				
09-772-02 Ø 2mm 17cm	09-773-03 Ø 3mm 17cm	09-774-04 Ø 4mm 17cm	09-775-05 Ø 5mm 17.5cm	09-776-06 Ø 6mm 17.5cm
				
09-777-07 Ø 7mm 18cm	09-778-08 Ø 8mm 18cm	09-779-10 Ø 10mm 19cm	09-780-12 Ø 12mm 20cm	09-781-14 Ø 14mm 20cm



Bone Curettes, oval,
Swedish Pattern
18 - 22cm

			
09-782-02 2mm 18cm	09-783-03 3mm 18cm	09-784-04 4mm 18.5cm	09-785-05 5mm 18.5cm
			
09-786-06 6mm 18.5cm	09-787-07 7mm 19cm	09-788-08 8mm 20cm	09-789-10 10mm 21cm
			
09-790-12 12mm 21cm	09-791-14 14mm 22cm		

BONE CURETTES

Scharfe Löffel

cucharillas cortantes

Curettes tranchantes

Cucchiai taglienti

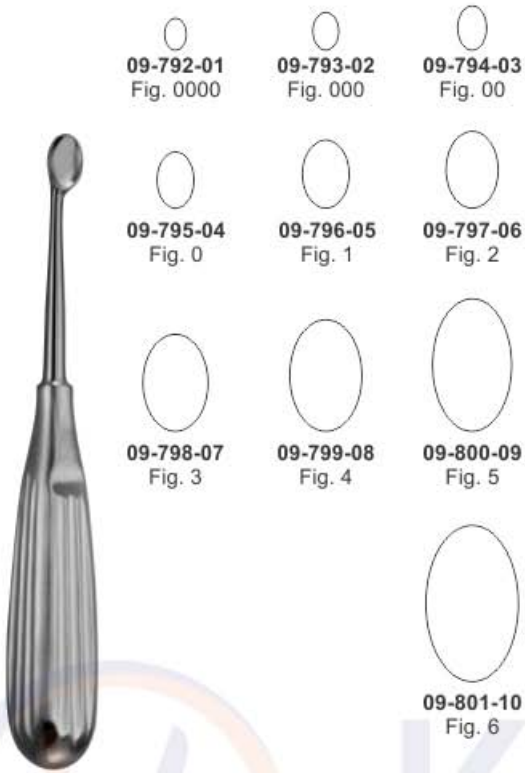

**Volkman
Bone Curette**
17cm



**Schede
Bone Curette**
17 cm

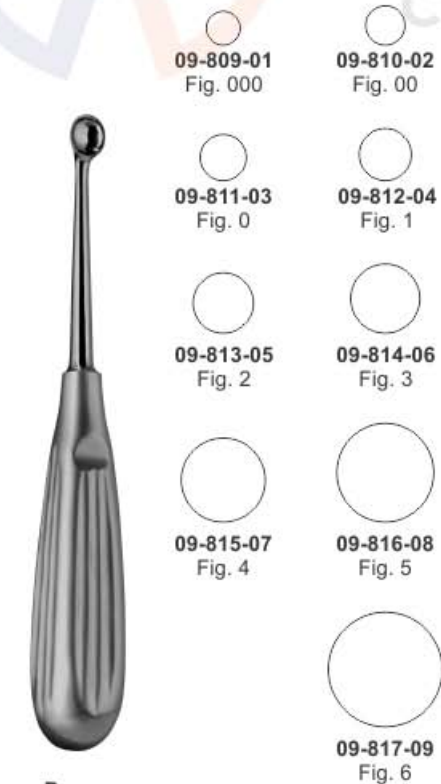

**Bruns
Bone Curette**
17cm

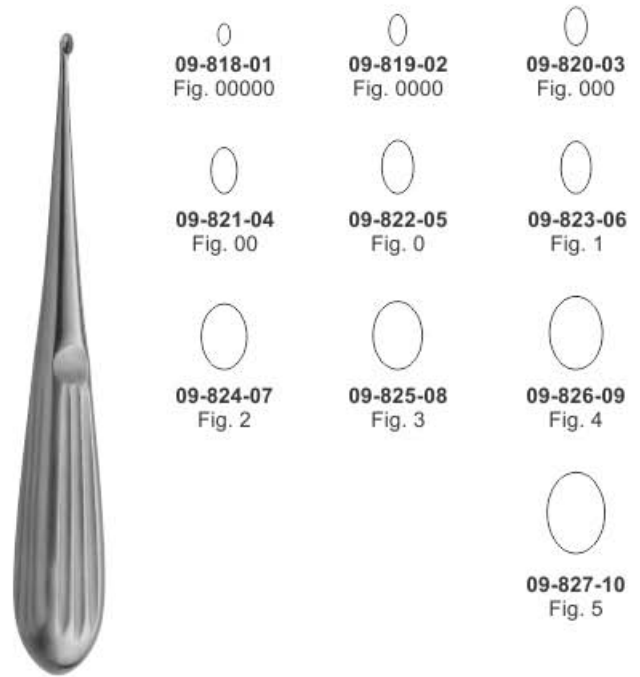

**Spratt Bone Curette
/ Hollow Handle**
16.5cm

BONE CURETTES

Scharfe Löffel

cucharillas cortantes

Curettes tranchantes

Cucchiai taglianti



- 09-828-01 Fig. 000000
- 09-829-02 Fig. 000000
- 09-830-03 Fig. 0000
- 09-831-04 Fig. 000
- 09-832-05 Fig. 00
- 09-833-06 Fig. 0
- 09-834-07 Fig. 1
- 09-835-08 Fig. 2



- 09-836-01 2.8mm Fig. 0000
- 09-837-02 3.6mm Fig. 000
- 09-838-03 4.4mm Fig. 00
- 09-839-04 5.2mm Fig. 0



- 09-840-01 3.6mm Fig. 000
- 09-841-02 4.4mm Fig. 00
- 09-842-03 5.2mm Fig. 0
- 09-843-04 6.8mm Fig. 1



- 09-844-01 4x10mm Straight
- 09-845-02 4x10mm Down Angle
- 09-846-03 4x10mm Up Angle

Lempert Bone Curette
20cm

Daubenspeck Bone Curette
20 cm

Bone Curette
25 cm
Straight

Scoville Bone Curette
25 cm



- Fig. 000
09-847-01 20cm
09-848-01 23cm
- Fig. 0
09-851-03 20cm
09-852-03 23cm
- Fig. 2
09-855-05 20cm
09-856-05 23cm
- Fig. 4
09-859-07 20cm
09-860-07 23cm
- Fig. 00
09-849-02 20cm
09-850-02 23cm
- Fig. 1
09-853-04 20cm
09-854-04 23cm
- Fig. 3
09-857-06 20cm
09-858-06 23cm
- Fig. 5
09-861-08 20cm
09-862-08 23cm
- Fig. 6
09-863-09 20cm
09-864-09 23cm

Bruns (Volkman)
Bone Curette
Straight



- Fig. 000
09-865-01 20cm
09-866-01 23cm
- Fig. 0
09-869-03 20cm
09-870-03 23cm
- Fig. 2
09-873-05 20cm
09-874-05 23cm
- Fig. 4
09-877-07 20cm
09-878-07 23cm
- Fig. 00
09-867-02 20cm
09-868-02 23cm
- Fig. 1
09-871-04 20cm
09-872-04 23cm
- Fig. 3
09-875-06 20cm
09-876-06 23cm
- Fig. 5
09-879-08 20cm
09-880-08 23cm
- Fig. 6
09-881-09 20cm
09-882-09 23cm

Bruns (Volkman)
Bone Curette
Curved

BONE CURETTES

Scharfe Löffel

cucharillas cortantes

Curettes tranchantes

Cucchiai taglianti



- Fig.1 09-883-01
- Fig.2 09-884-02
- Fig.3 09-885-03
- Fig.4 09-886-04
- Fig.5 09-887-05
- Fig.6 09-888-06
- Fig.7 09-889-07
- Fig.8 09-890-08
- Fig.9 09-891-09

Bruns Bone Curette
23 cm



- 09-892-01 Fig. 1 4mm
- 09-893-02 Fig. 2 5mm
- 09-894-03 Fig. 3 6mm

Halle Bone Curette
Malleable
21cm



- Fig. 0000 09-895-01
- Fig. 000 09-896-02
- Fig. 00 09-897-03
- Fig. 0 09-898-04
- Fig. 1 09-899-05
- Fig. 2 09-900-06
- Fig. 3 09-901-07
- Fig. 4 09-902-08
- Fig. 5 09-903-09
- Fig. 6 09-904-10

Simon Bone Curette
24cm



- Fig. 1 09-905-01 09-911-01
- Fig. 2 09-906-02 09-912-02
- Fig. 3 09-907-03 09-913-03
- Fig. 4 09-908-04 09-914-04
- Fig. 5 09-909-05 09-915-05
- Fig. 6 09-910-06 09-916-06

Schroeder Bone Curette 25cm
09-905-01 to 09-910-06

Schroeder Bone Curette 30cm
09-911-06 to 09-916-06



Volkman Bone Curette
Oval, with fiber handle



- 09-917-01 18.5 cm Fig. 0000
- 09-918-02 18.5 cm Fig. 000
- 09-919-03 18.5 cm Fig. 00
- 09-920-04 18.5 cm Fig. 0
- 09-921-05 18.5 cm Fig. 1
- 09-922-06 18.5 cm Fig. 2
- 09-923-07 19 cm Fig. 3
- 09-924-08 19 cm Fig. 4
- 09-925-09 19 cm Fig. 5
- 09-926-10 19 cm Fig. 6
- 09-927-11 27.5 cm Fig. 0
- 09-928-12 27.5 cm Fig. 1
- 09-929-13 27.5 cm Fig. 2
- 09-930-14 27.5 cm Fig. 3
- 09-931-15 27.5 cm Fig. 4

PERIOSTEAL ELEVATORS

Raspatorien
Periostótomos

Rugines-raspatoires
Periostotomi

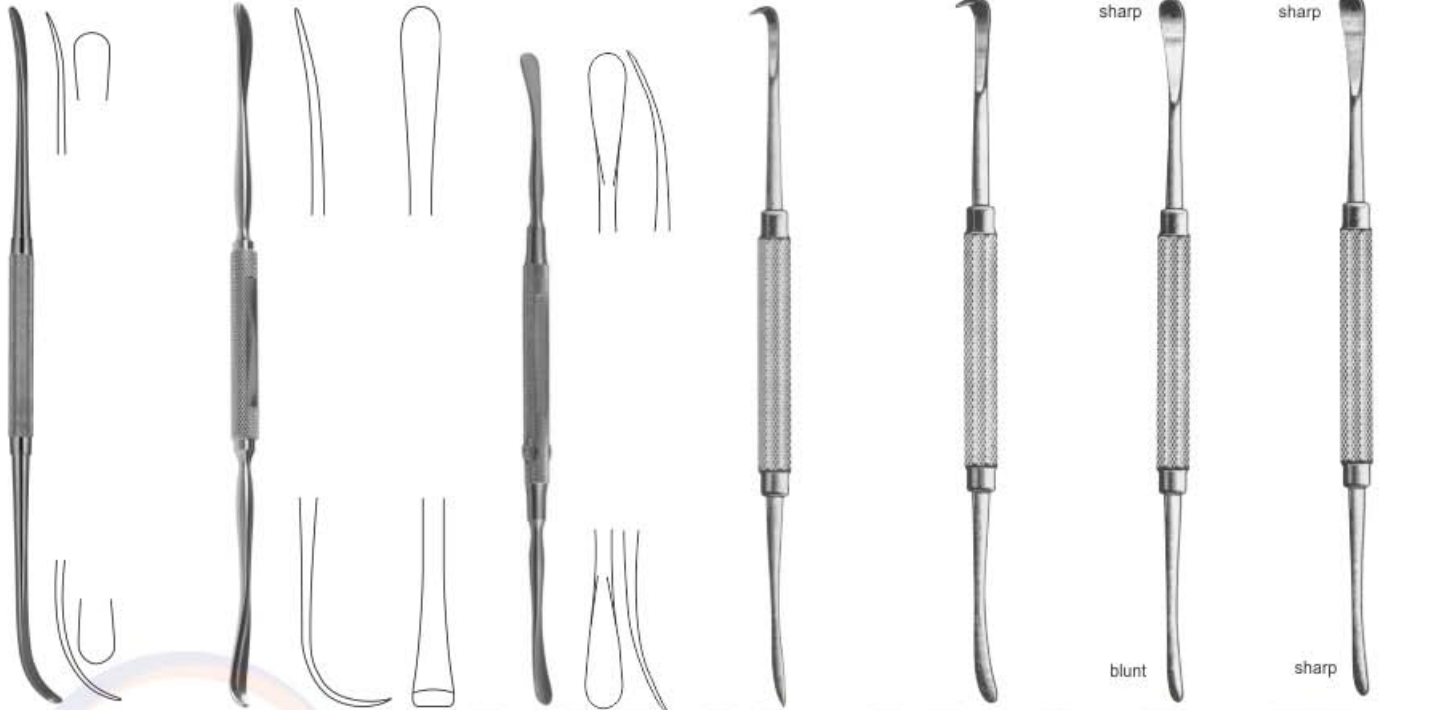

Obwegeser-Freer Elevator
09-932-21
21 cm

Obwegeser-Freer Elevator
09-933-21
21 cm

Freer Elevator
09-934-18
18.5 cm
double ended
5 mm sharp end
5 mm blunt end

Molt Periosteal elevator
09-935-01
18cm

Molt
09-936-02
18cm

Molt
09-937-03
18cm
sharp
blunt

Molt
09-938-04
18cm
sharp
sharp

C O R P O R A T I O N

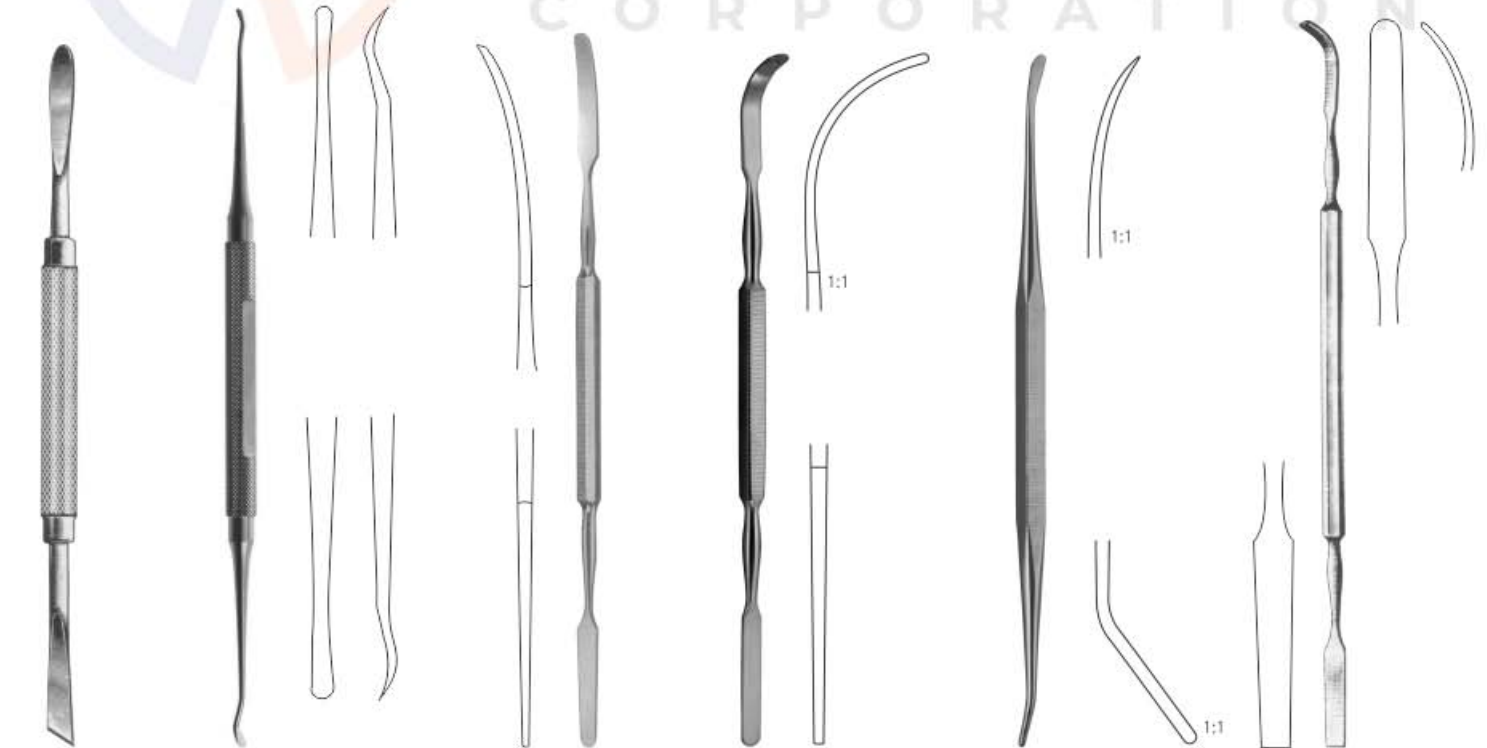

Mead
09-939-16
16,5cm

Kleinert Kutz Elevator and Dissector
09-940-19
19.5 cm
2 mm x 3 mm Sharp ends

MacDonald
09-941-19
19cm

Mc Donald Elevators
09-942-19 19 cm
double ended

Watson-Cheyne Elevators
09-943-19 19 cm
double ended

Cohen
09-944-24
24cm

PERIOSTEAL ELEVATORS

Raspatorien
Periostótomos

Rugines-raspatoires
Periostotomi

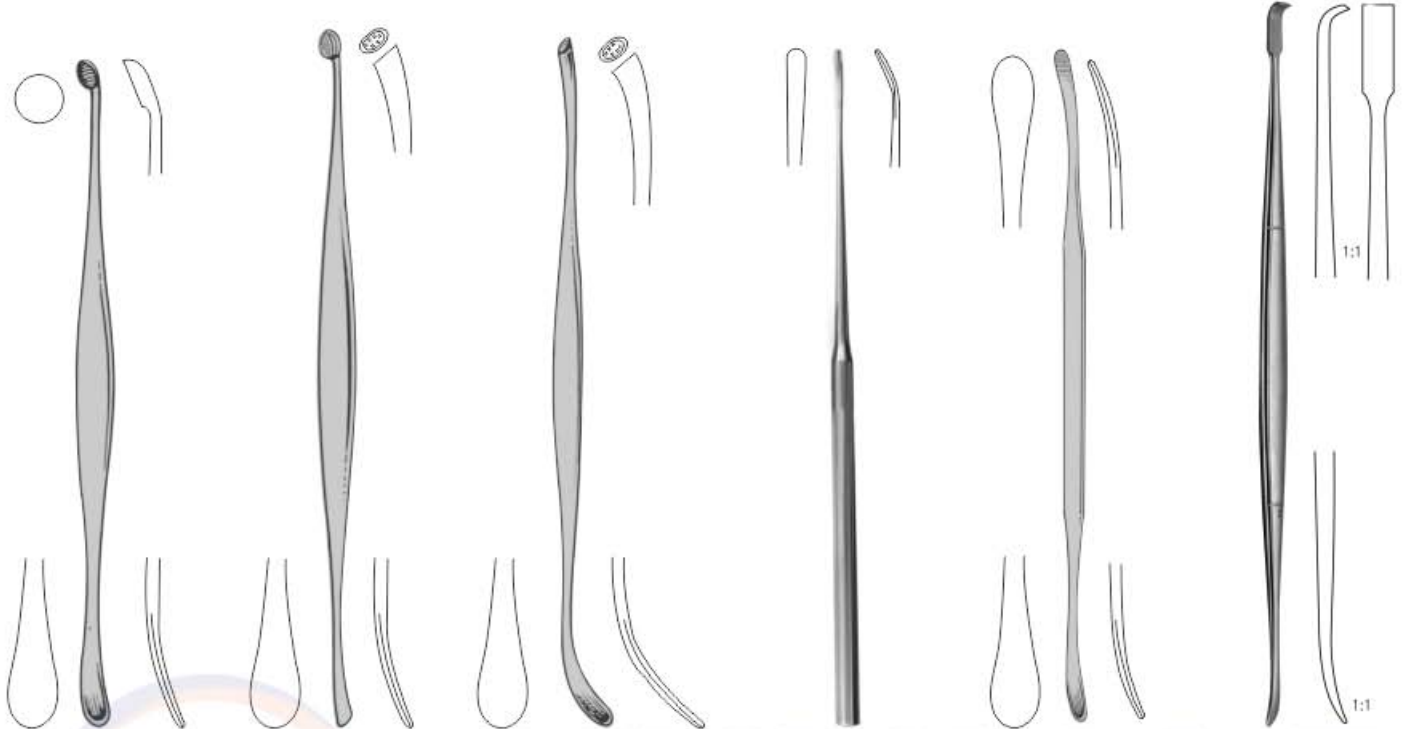

Penfield Elevators
09-945-01
style #1
17.5 cm
double ended

Penfield Elevators
09-946-02
style #2
18.5 cm
double ended

Penfield Elevators
09-947-03
style #3
18.5 cm
double ended

Penfield Elevators
09-948-04
style #4
18.5 cm
single ended

Penfield Elevators
09-949-05
style #5
18.5 cm
double ended

Howarth Periosteal Elevator
09-950-21
21.5cm
Sharp / Blunt

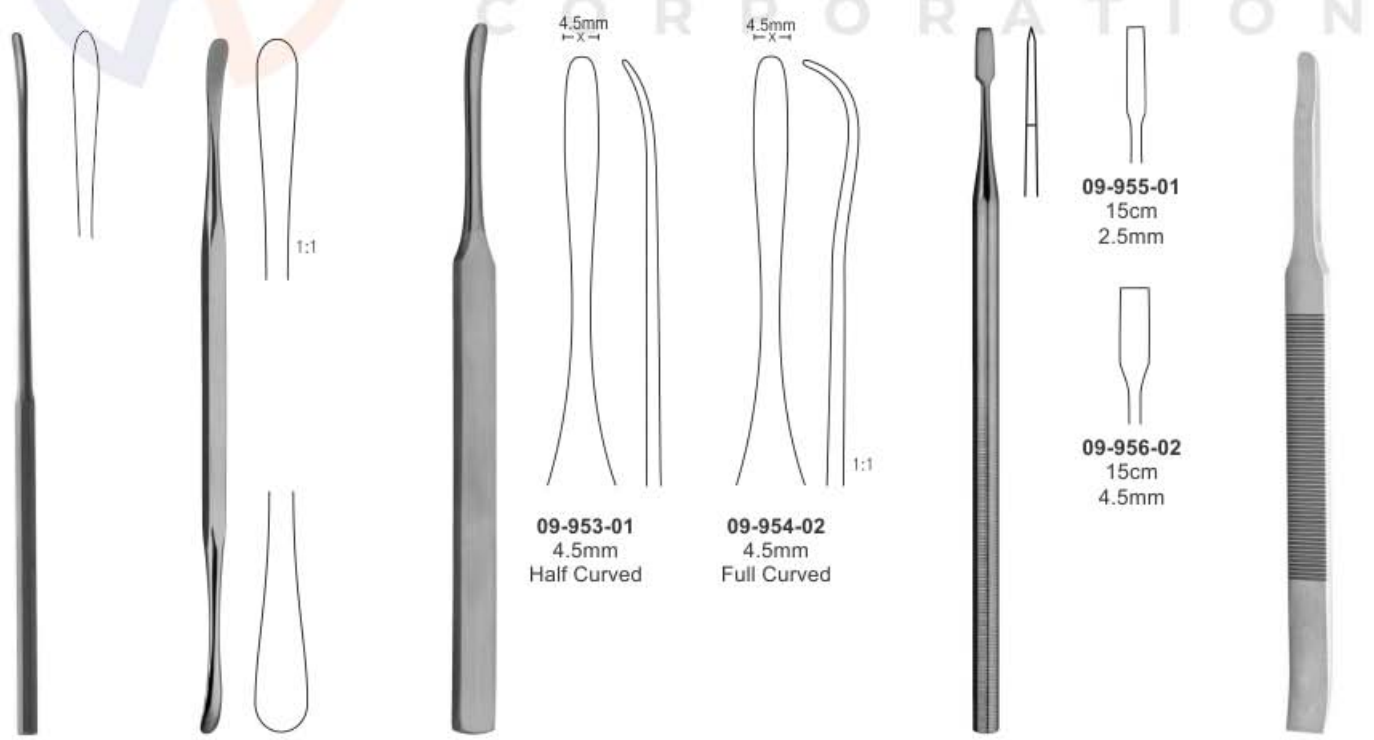

Sachs Nerve Elevator
09-951-18
18.5 cm
3 mm blunt

Alderdyce Elevators
09-952-21 21.5 cm
double ended

Konig Elevator
15.5cm

09-953-01
4.5mm
Half Curved

09-954-02
4.5mm
Full Curved

Obwegeser Elevator

09-955-01
15cm
2.5mm

09-956-02
15cm
4.5mm

Carroll Periosteal Elevator
09-957-14 14 cm
sharp, double ended
3 mm round end,
10 mm flat end



Obwegeser Elevator

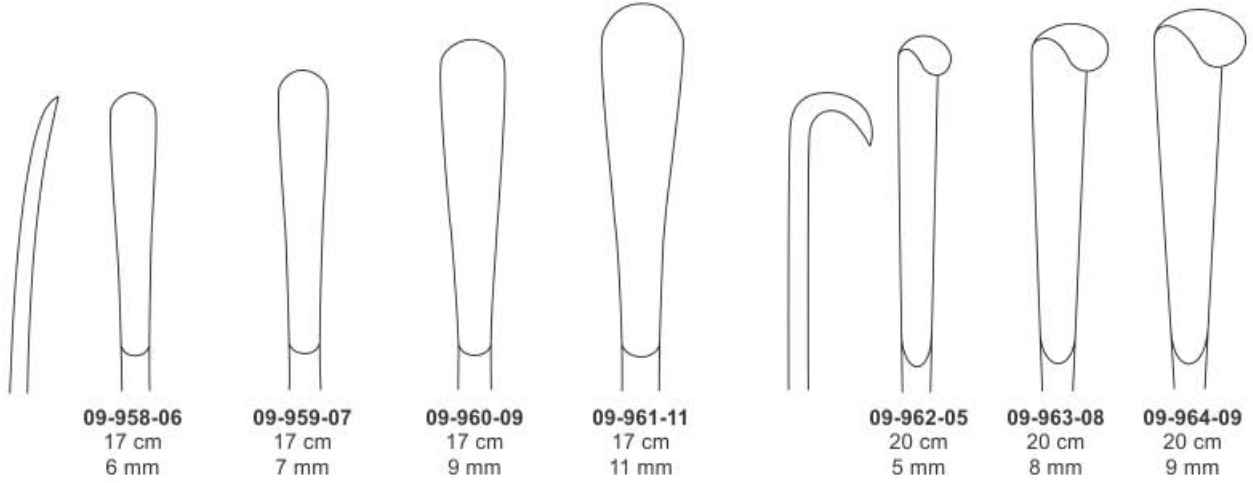

09-958-06
17 cm
6 mm

09-959-07
17 cm
7 mm

09-960-09
17 cm
9 mm

09-961-11
17 cm
11 mm

09-962-05
20 cm
5 mm

09-963-08
20 cm
8 mm

09-964-09
20 cm
9 mm

KUMMAS
CORPORATION

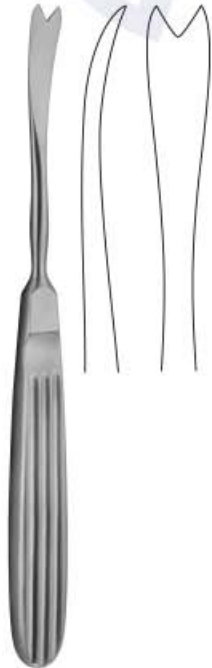

Obwegeser Elevator
09-965-17
17.5 cm

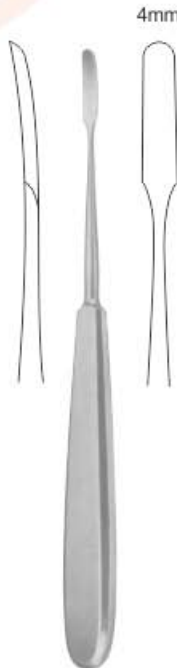

Joseph Elevator
09-966-16
16,5cm

4mm



Lempert Elevator
17cm

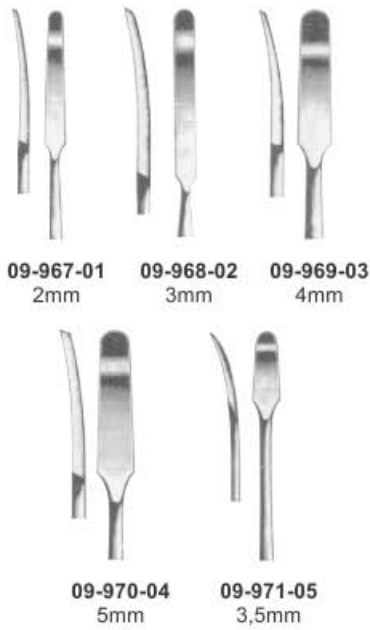

09-967-01
2mm

09-968-02
3mm

09-969-03
4mm

09-970-04
5mm

09-971-05
3,5mm



Adson Elevator
17cm



09-972-01
Fig. 1



09-973-02
Fig. 2



09-974-03
Fig. 3

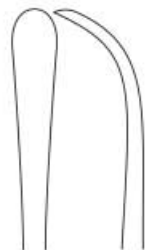

09-975-04
Fig. 4

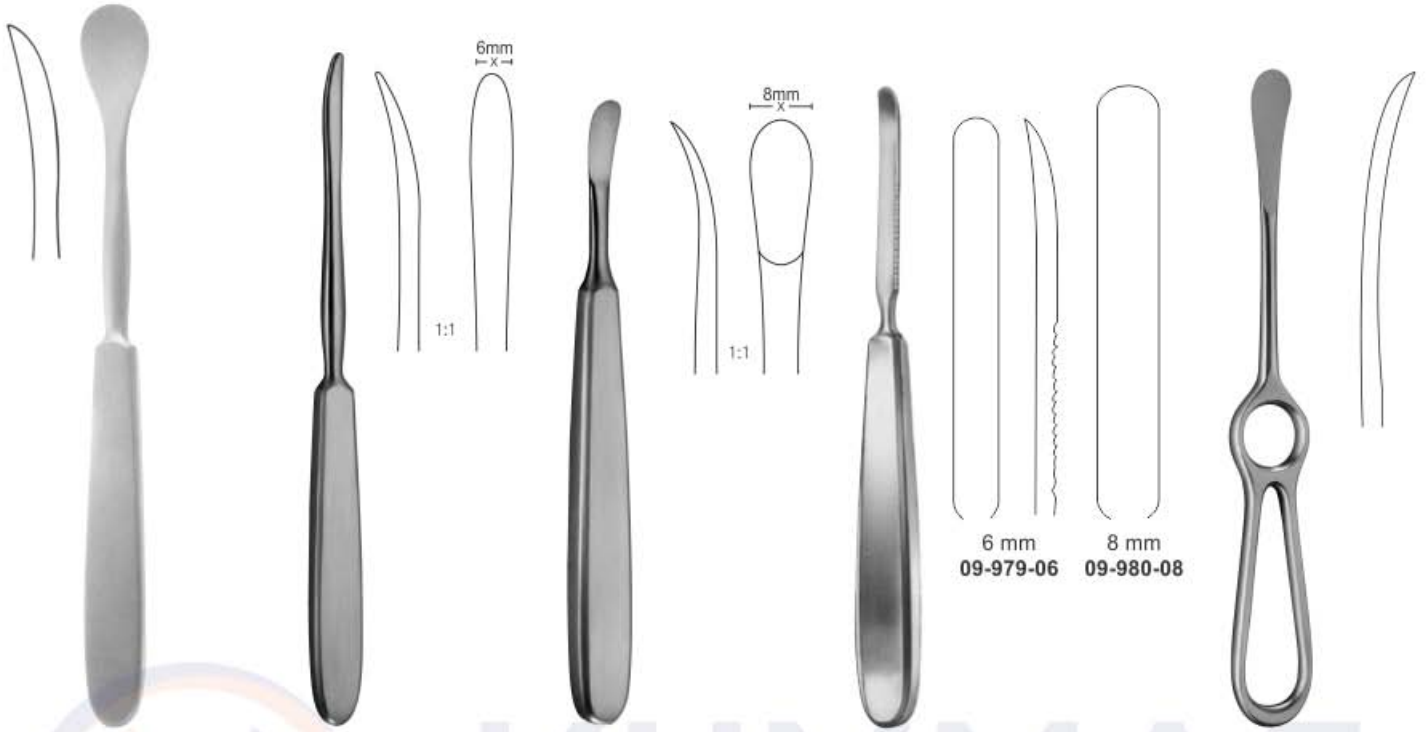

Sedillot Elevator
09-976-19
19cm

Quervain Elevator
09-977-19 6mm
19.5cm

Trelat Elevator
09-978-15 8mm
15cm

Periosteal Elevator
17 cm

Sedillot Elevator
09-981-21 21cm

6 mm 09-979-06
8 mm 09-980-08



Langenbeck Periosteal Elevator
09-982-15 15 mm
19 cm
sharp, slightly curved

Langenbeck Periosteal Elevator
20 cm Blunt

Langenbeck Periosteal Elevator
19.5 cm
09-985-19 sharp edge
09-986-19 blunt edge

Langenbeck
09-987-23
23cm

Langenbeck Periosteal Elevator
09-988-18
18cm

Langenbeck Periosteal Elevator
09-989-19 19cm

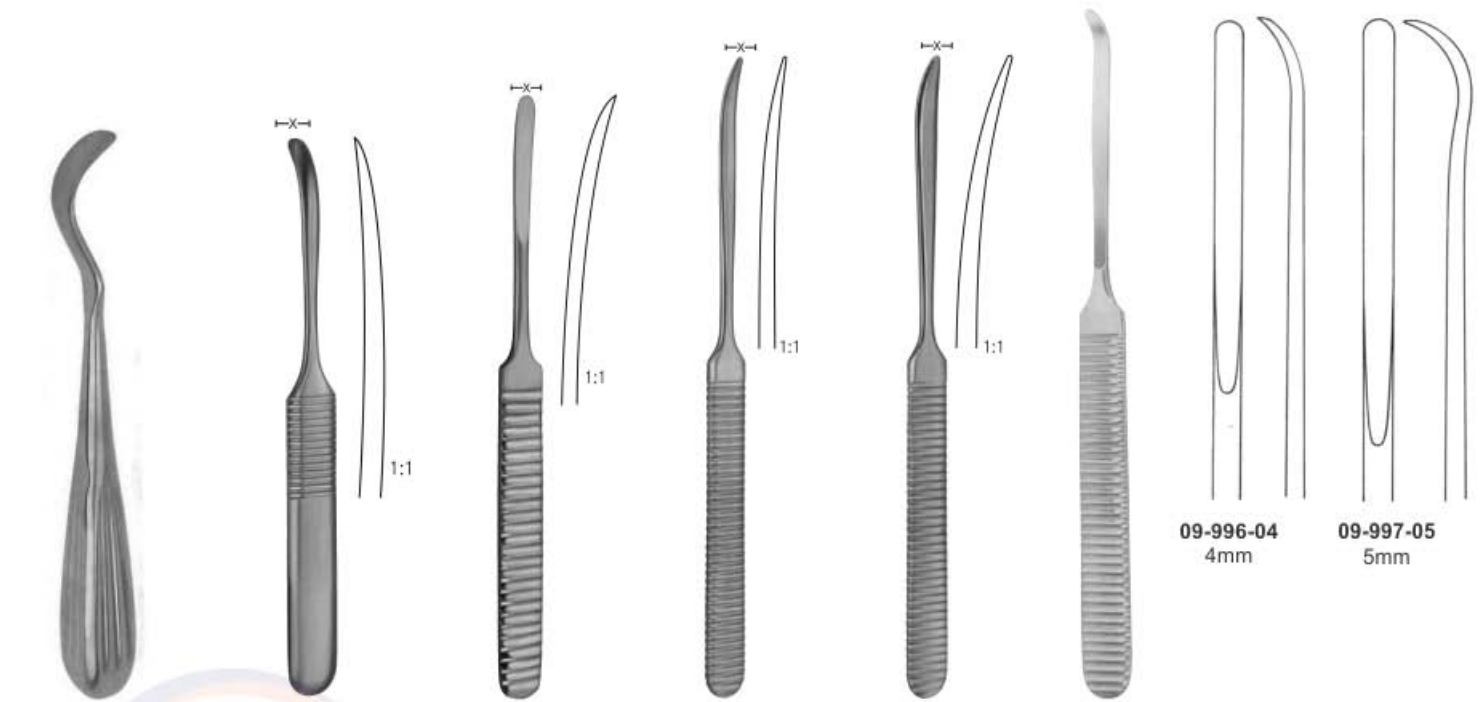

Crego Periosteal Elevator
09-990-15
15.5cm

Williger Elevator
09-991-13 13cm
09-991-14 5mm

Williger Elevator
09-992-04 4mm
09-993-06 6mm
16cm

Williger Elevator
09-994-01 16cm
5mm

Williger Elevator
09-995-02 16cm
6.5mm

Kahre-Williger
16cm

09-996-04
4mm

09-997-05
5mm

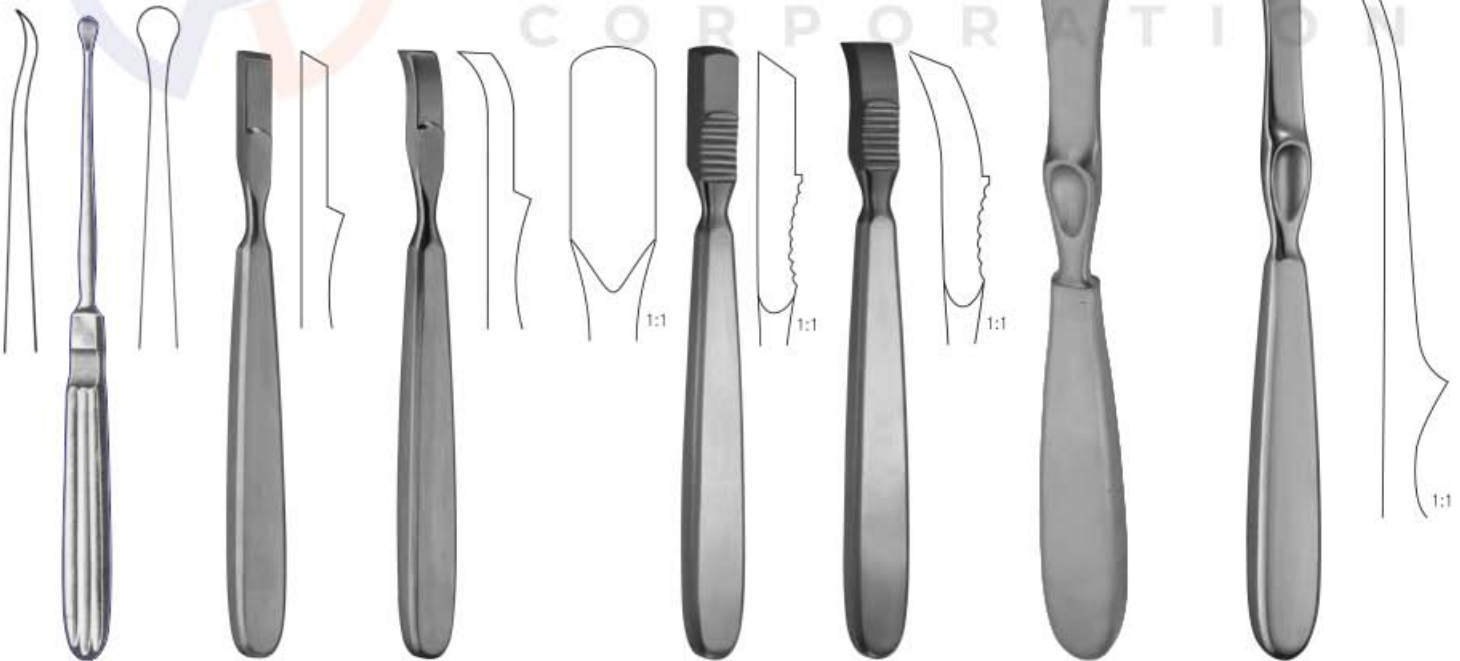

Ward
09-998-19
19cm

Farabeuf-Collin Elevator
09-999-11 16cm
11mm
Straight

Farabeuf-Collin Elevator
09-1000-11 16cm
11mm
Curved

Farabeuf Elevator
09-1001-15
15cm
Straight

Farabeuf Elevator
09-1002-15
15cm
Curved

Lambotte Elevator
09-1003-05 5mm
09-1004-10 10mm
09-1005-15 15mm
09-1006-20 20mm
09-1007-25 25mm
21cm Straight

Lambotte Elevator
09-1008-05 5mm
09-1009-10 10mm
09-1010-15 15mm
09-1011-20 20mm
09-1012-25 25mm
21cm Curved

PERIOSTEAL ELEVATORS

Raspatorien

Rugines-raspatoires

Periostótomos

Periostotomi

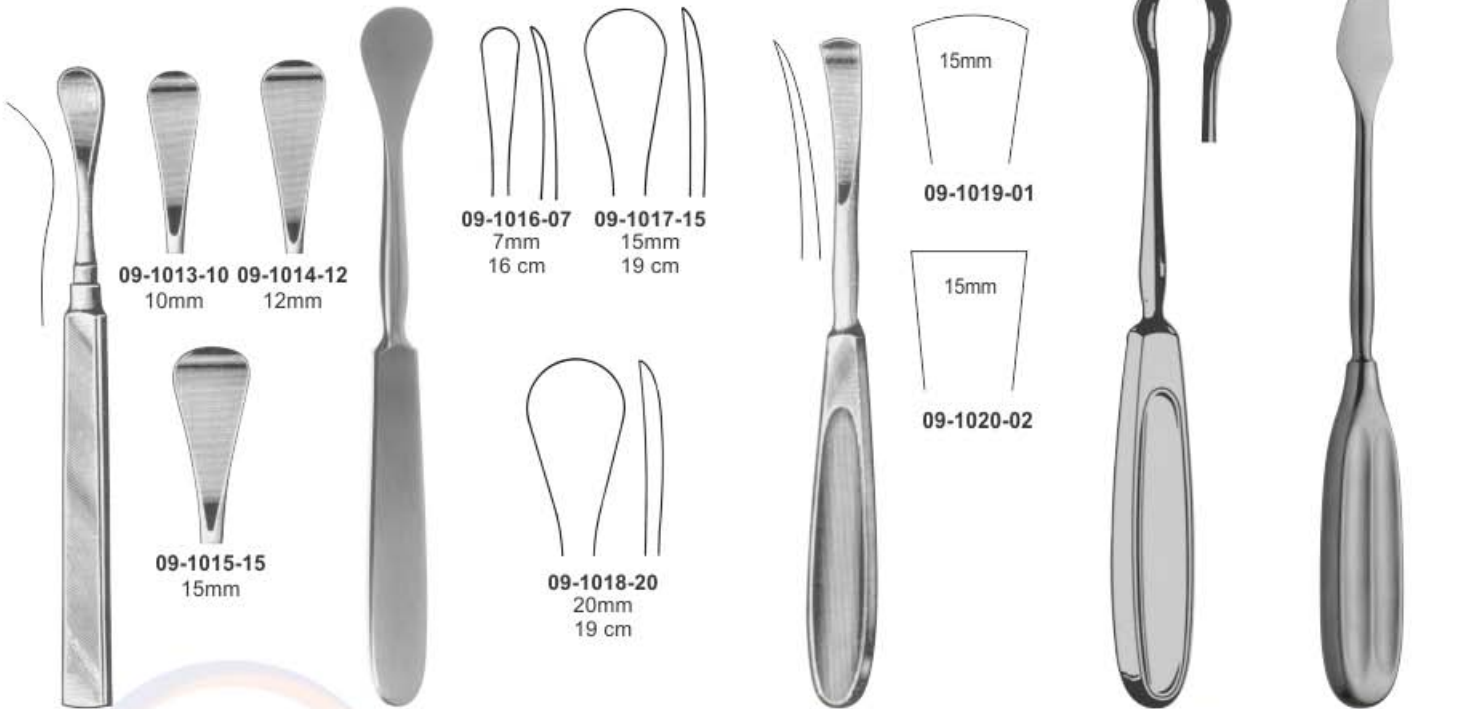

Henahan
17cm
semi-sharp

Hoen Periosteal Elevator
Semisharp

Cushing Periosteal Elevator
15 mm
09-1019-01 Round Edge
09-1020-02 Square Edge
18 cm

Cushing Periosteal Elevator
19 cm
09-1021-01 Left
09-1022-02 Right

Chandler Bone Elevator
09-1023-19 19cm
13 mm
09-1024-20 20cm
20 mm
09-1025-23 23cm
25 mm
09-1026-25 25cm
31 mm



Obwegeser Elevator
09-1027-18
18.5cm

Obwegeser - Freer Osteotome Elevator
09-1028-18
18.5cm



09-1029-01
17.5cm
12mm

09-1030-02
21cm
12mm

09-1031-03
17.5cm
12mm

09-1032-04
21cm
13mm

09-1033-05
22.5cm
13mm

09-1034-06
22.5cm
15mm

Semb Periosteal Elevator

PERIOSTEAL ELEVATORS

Raspatorien
Periostótomos

Rugines-raspatoires
Periostotomi



Alexander Periosteal Elevator
09-1035-20 20cm



Key Periosteal Elevator
slightly curved
Hexagonal Handle
sharp



09-1036-08
18cm
8mm



09-1037-10
19cm
10mm

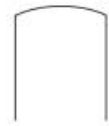

09-1038-12
19cm
12mm



09-1039-19
20cm
19mm



09-1040-25
21cm
25mm



Cobb Periosteal Elevator
23.4 cm
Hexagonal Handle
sharp



09-1041-12
12 mm



09-1042-19
19 mm



09-1043-25
25 mm



09-1044-32
32 mm



Raspatries
09-1045-28
28cm



Harrington Spinal Elevator
09-1046-30 30 cm
19 mm tip width
Sharp



09-1047-07 7 mm



09-1048-09 9 mm



Cobb Modif.
28 cm
Round Handle



09-1049-11
11 mm



Cobb Periosteal Elevator
09-1050-10 10mm
09-1051-13 13mm
09-1052-19 19mm
29cm
Spinal raspatory



09-1053-04 4 mm



09-1054-06 6 mm



Cobb Modif.
28 cm
Round Handle



09-1055-08
8 mm



Raspatories
09-1056-20 20cm
Medium straight
blade round edge,
width 14mm

Raspatories
09-1057-20 20cm
Large straight
blade round edge,
width 20mm

Raspatories
09-1058-20 20cm
Medium curved
blade round edge,
width 14mm

Raspatories
09-1059-20 20cm
Large curved
blade round edge,
width 20mm

Raspatories
09-1060-28
28cm

Periosteal Elevator
09-1061-18 18 cm
Fiber Handle
blade 6mm

**Periosteal
Raspatories**
09-1062-18
18.5cm
Curved

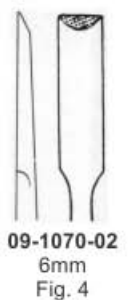
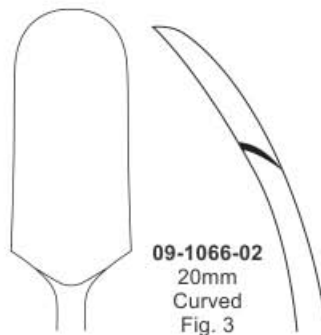
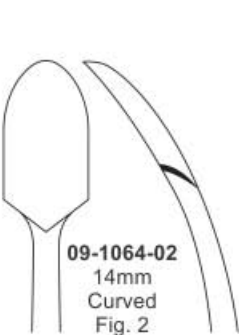
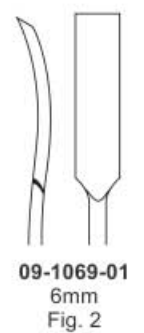
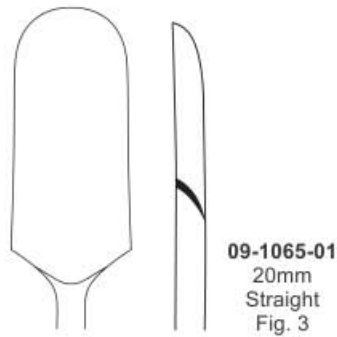
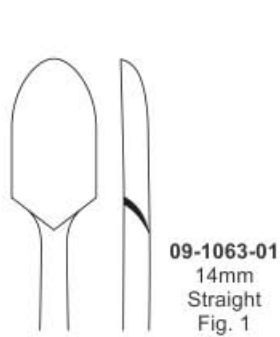

Ferrozell Periosteal Elevator
20cm

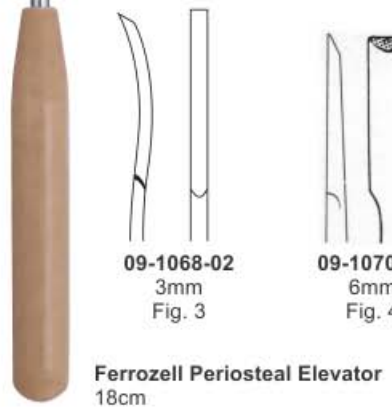

PERIOSTEAL ELEVATORS, RIB RASPARTORY

Periotheber, Rippenraspatorium

Elevadores de periostio, raspador de costillas

Élévateurs périostés, râpe à côtes

Ascensori periostale, Raspatory costale



Sayre Periosteal Elevator
09-1071-17 17 cm
one straight blunt
and one curved sharp



Pennybacker Periosteal Elevator
09-1072-17 6 mm
17 cm
sharp, curved



Sebileau Periosteal Elevator



09-1073-17
17.5 cm



Darrach Elevator
09-1074-26 26cm 19mm
09-1075-35 35cm 25.4mm
Blunt, Slightly Curved



JANSEN
09-1076-16
16.5cm



13mm



SCHNEIDER
09-1077-17
17.5cm



SCHNEIDER-SAUERBRUCH
09-1078-19
19cm

13mm

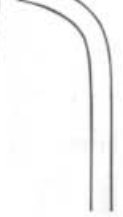

C O R P O R A T I O N



St. Thomas
09-1079-16
16 cm
Pointed



St. Thomas
09-1080-16
16 cm
Rounded



Robinson's
09-1081-17
17 cm



Doyen Rib Raspatory
18 cm



09-1082-01
Right Curved
For Adults



09-1084-01
Left Curved
For Adults



09-1083-02
Right Curved
For Children



09-1085-02
Left Curved
For Children



Doyen Rib Raspatory
17 cm

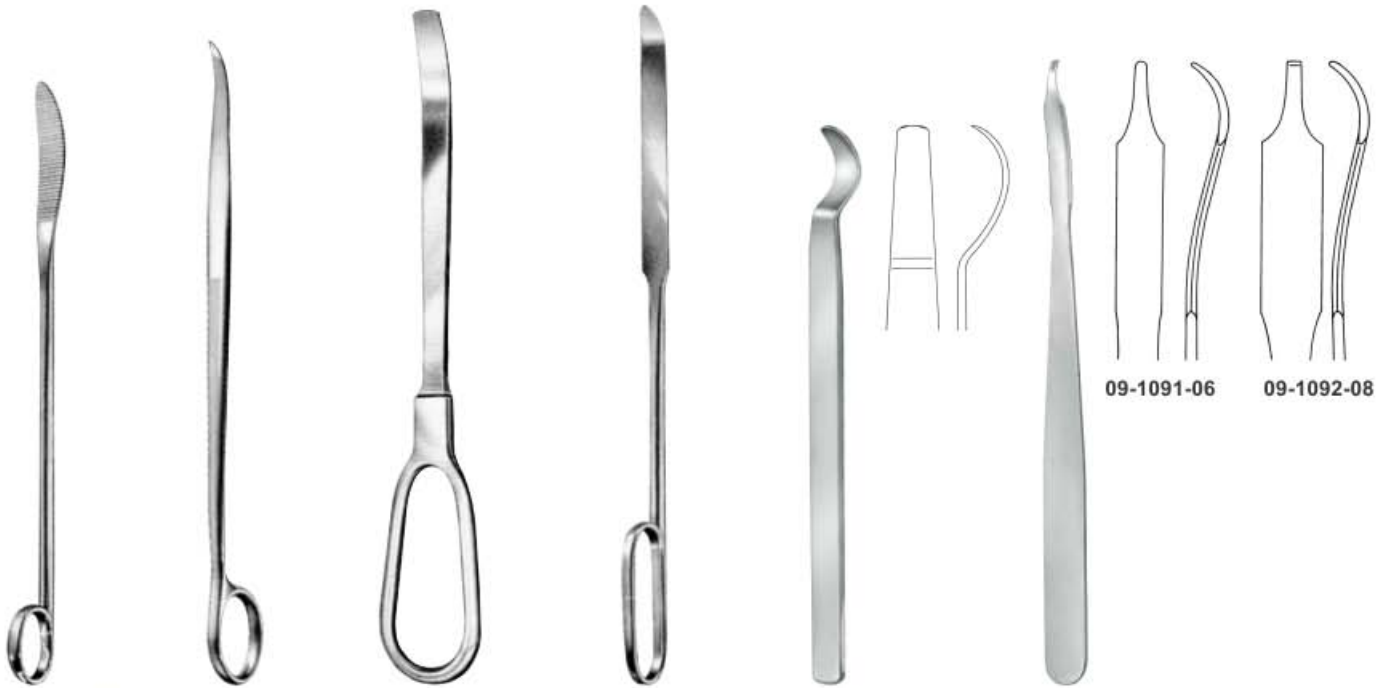

Lane Bone Elevator
09-1086-16 16 cm
Serrated

Trethowan's Bone Elevator
09-1087-22 22 cm

Bristow's Bone Lever
09-1088-23
23cm

Lane Bone Elevator
09-1089-27 27 cm

09-1090-02
14cm

Mini-Hohmann
16cm

09-1091-06

09-1092-08



Hohmann
09-1093-08
8mm



Hohmann
09-1094-18
18mm



Hohmann
09-1095-43
43mm

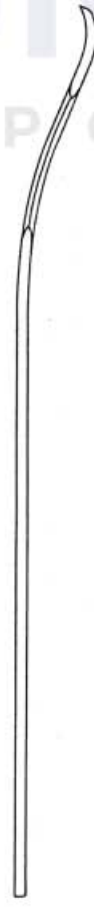

Hohmann
09-1096-70
70mm

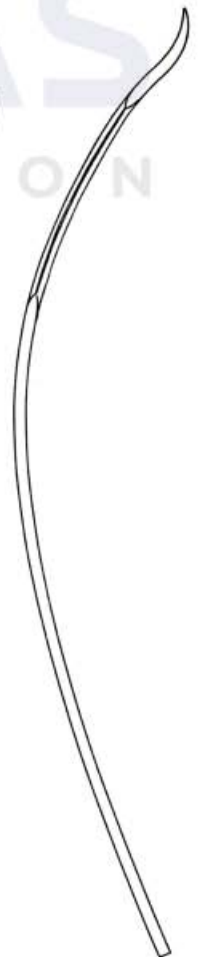



Hohmann
09-1097-01
43mm

Hohmann
09-1098-02
22mm

Hohmann
09-1099-03
33mm

Hohmann
09-1100-04
24mm

Lange-Hohman
09-1101-05
22mm

MENISCOTOMY KNIVES

Meniskotome

Bisturies para meniscos

Bistouries a menisques

Bisturi per menisco



Freer D Septum Knife
09-1102-15 15cm



Bircher Meniscotomy Knife
09-1103-19 19cm



Downing Cartilage Knife
09-1104-25 25.5cm
Curved tip, Straight shaft



Matson Meniscotomy Knife
09-1105-22 22 cm



Smillie Meniscotomy Knife
09-1106-16
16cm Straight Shaft
Blade tip width is 7.8mm
Straight tip



Smillie Meniscotomy Knife
09-1107-16
16cm Curved Shaft
Blade tip width is 7.8mm
Curved left tip

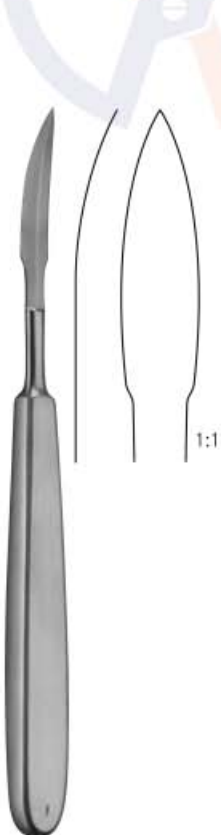

Meniscotomy Knife
09-1108-18 18cm



Neff Meniscotomy Knife
22cm



09-1109-01
left



09-1110-02
right

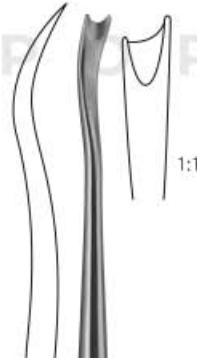

Kanadisches Modell Meniscotomy knife
09-1111-01 20cm

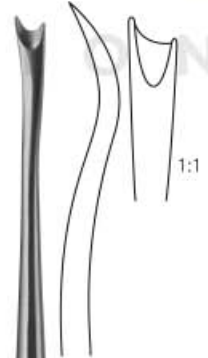

Kanadisches Modell Meniscotomy knife
09-1112-02 20cm



09-1113-01 4mm
09-1114-02 4.5mm
09-1115-03 5.5mm

Bunnell Tendon Strippers
23cm
Malleable shaft



09-1116-01 Fig. 1 3mm
09-1117-02 Fig. 2 4mm
09-1118-03 Fig. 3 5mm
09-1119-04 Fig. 4 6mm
09-1120-05 Fig. 5 7mm

Bunnell Tendon Strippers
15.2cm



Fischer Tendon Strippers
09-1121-31 31cm



Bunnell Tendon Strippers
09-1122-23 23cm
Tendon passer



Kleinert-Kutz Tendon Retriever
09-1123-20 20cm
Serrated



Kleinert-Kutz Tendon Retriever
09-1124-20 20cm
Serrated, flexible shaft



Brand Tendon Tunelling Forceps

09-1125-15 15 cm
09-1126-19 19 cm
09-1127-24 24 cm
Straight, serrated
2 x 3 teeth



Nail Extracting Forceps
09-1128-14 14 cm



Nail Extracting Forceps
09-1129-14 14.5 cm



Nail Extractor
09-1130-16 16 cm
with Longitudinal Grove
(for Intramudullary Gliding Nails)



Nail Splitting Forceps
09-1131-13
13.5 cm



KUMMAS
CORPORATION

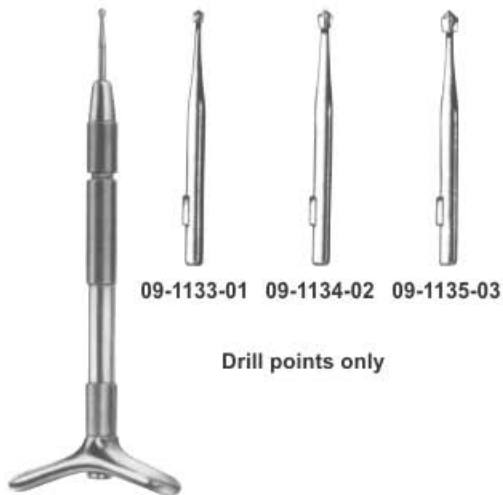

Finger Nail Drill
with 3 drill points
09-1132-00

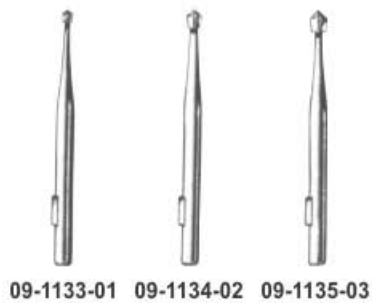

Drill points only



Ring Cutter
09-1136-17
17 cm



Saw Blade Only
for 09-1137-01



Ring Cutter
09-1138-17
17 cm



Saw Blade Only
for 09-1139-01



Tendon Tunelling Forceps
09-1140-13 13cm



09-1141-15
15cm

Tendon Tunelling Forceps

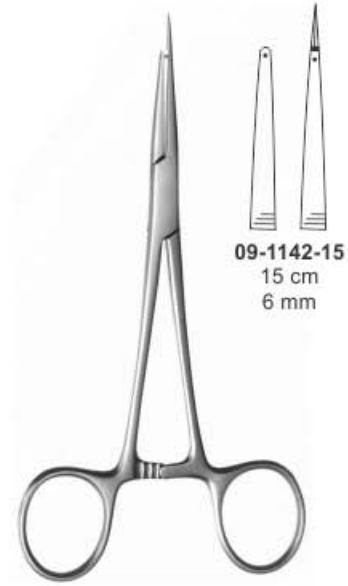

09-1142-15
15 cm
6 mm

Tendon Tunelling Forceps



KUMMAS
CORPORATION



Brand Tendon Forceps
09-1143-15 15 cm
09-1144-19 19 cm
09-1145-24 24 cm



Carroll Tendon Forceps
09-1146-13 13 cm
Curved Shaft
2 mm x 6 mm

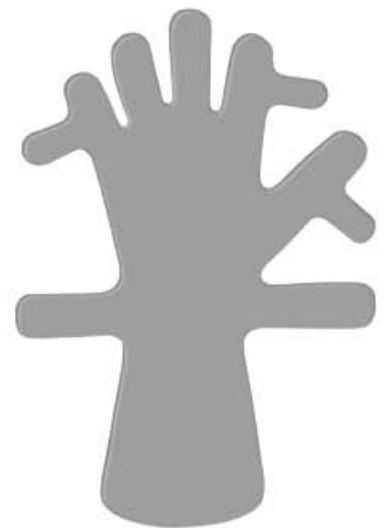

Lead Hand
09-1147-00
Adult Size



09-1148-14
14 cm
Cross serrated

Flat Nose Pliers



09-1149-19
19 cm
Serrated

Flat Nose Pliers



Flat Nose Pliers
09-1150-13
13.5cm
Broad, 4mm tip,



Flat Nose Plier
09-1151-18
18 cm



Needle Nose Pliers
09-1152-13 13.5cm



Flat Nose Pliers
09-1153-15
15cm Delicate, 1.5mm tip



K-Wire Extraction Pliers
W/Screw Lock
09-1154-13
13cm 3mm tip



Pin Puller W/ Groove TC
09-1155-14 14cm



**Synthes Inserter/Extractor
with Adjustable Clamps**
09-1156-00



Extractor Plier
09-1157-13 13 cm



Rounded Pliers
09-1158-15 15cm
with Serrated jaw



Plier
09-1159-15 15cm
with serrated
jaw & without groove



Plier
09-1160-15 15cm
with serrated
jaw & groove



Wire Bender
09-1161-20
20cm

TECHNICAL PLIERS

Technische Zangen

Alicates Técnicos

Pinces techniques

Pinze tecniche



Flat Nose K-Wire Pliers
09-1162-14 14 cm
09-1163-17 17 cm



Utility Technical Forceps Pliers
09-1164-19 19cm adjustable



Vital Heavy Duty Pliers TC
09-1165-22 22cm
Grip Forceps, Combined with cutter



Vital Wire Extraction Pliers T.C
09-1166-05 5mm
09-1167-07 7mm
18cm



Flat Nosed Plier
09-1168-18 18 cm
parallell, with lateral wire cutter



Needle-Nose Locking Pliers
09-1169-01



Needle-Nose Locking Pliers
09-1170-01



Needle-Nose Locking Pliers
09-1171-01



Wire Bending Forceps
09-1172-18 18.5cm



Flat Nose Plier
09-1173-18 18.5cm
parallel grip, incorporated
cutter, for hard wires up to
1.6mm



Hercules Type Wire Cutter
09-1174-18
18cm



Locking Plier
09-1175-18 18cm
09-1176-20 20cm
09-1177-24 24cm



Plate Bending Plier
09-1178-20 20cm
for plates up to 2.7mm
09-1179-24 24cm
for plates up to 4mm



Hercules Type Wire Cutter
09-1180-28
28cm



Locking Plier
09-1181-22 22cm
09-1182-25 25cm
09-1183-30 30cm
Locking Plier, only
09-1184-30 30cm
with holding pins
09-1185-46 46cm
with extraction device

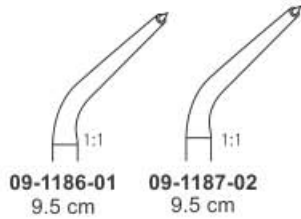

Bone Holding forceps



Bone Reduction Forceps
09-1188-13 13.5 cm



Bone Reduction Forceps
09-1189-13 13.5 cm
for maxillary reposition

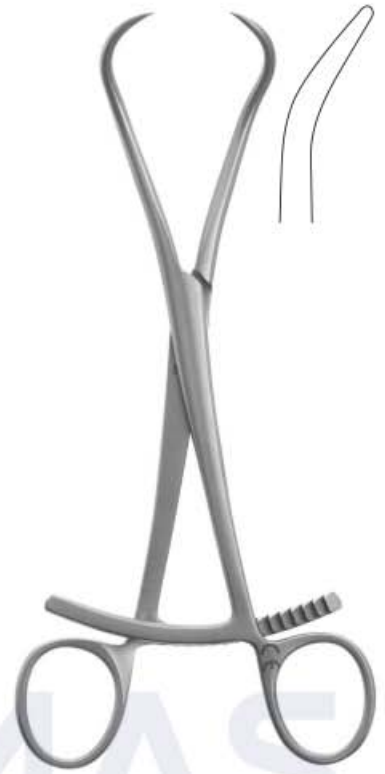

Bone Reduction Forceps
09-1190-20 20 cm
Pointed tips

C O R P O R A T I O N



Stagbeetle Bone Reduction Forceps
09-1191-13
Pointed tips, 13 cm



Haase
09-1192-16 16.5 cm
for mandibular fractures



Reill Bone Holding Forceps
09-1193-17 17 cm



Glenoid Perforating Forceps
09-1194-17 17 cm
Lightly curved, pointed tips
Strongly curved, pointed tips



Bone Reduction Forceps
09-1195-14 14cm



Locke Phalangeal Forceps
09-1196-14 14cm



Lewin Perforating Bone Holding Forceps
09-1197-17 17.5cm
serrated



09-1198-13
13.5 cm
Angled Serrated



Bone Reduction Forceps
09-1199-14 14 cm Curved
09-1200-15 15 cm Serrated



Bone Reduction Forceps,
Pointed Tips
09-1201-14 14 cm Serrated
09-1202-14 14 cm Curved
09-1203-17 17 cm Curved



Malleolar Bone Holding Forceps
09-1204-21 21 cm
Straight, 1 x 1 teeth



Plate & Bone Holding Forceps
09-1205-14 14 cm

Plate & Bone Holding Forceps
09-1206-14 14 cm
Curved

Fibula Bone Holding Forceps
09-1207-22 22 cm



Wilkinson Orthopaedic Locking Forceps
09-1208-21 21.5 cm
Straight, 1 x 1 teeth

Bone Holding Forceps
09-1209-01

Bone Holding Forceps
09-1210-01

Bone Holding Forceps
09-1211-01

BONE HOLDING FORCEPS

Knochenhaltezaugen
Daviers porte-so

Pinzas para huesos
Tenaglie per ossa



Meniscus Clamp
09-1212-01 13.5cm
Serrated



Meniscus Clamp
09-1213-02 13.5cm
Angled 20°, serrated



Meniscus Clamp
09-1214-18 18cm
Straight, Curved shaft



**Preston Logamentum
Flavum Forceps**
09-1215-19 19 cm
Curved, 1 x 2 teeth



**Dingman
Bone Holding Forceps**
light pattern, angled to side.
09-1216-01
19cm



**Dingman
Bone Holding Forceps**
heavy pattern, one jaw slotted
angled to side,
09-1217-02
19cm



Martin Cartilage Bone Holding Clamp Forceps
09-1218-19 19 cm
Straight

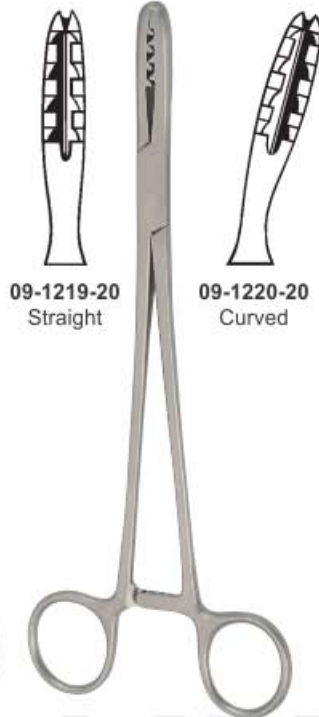

09-1219-20
Straight

09-1220-20
Curved

Bircher-Ganske
20cm
Bone Holding Forceps

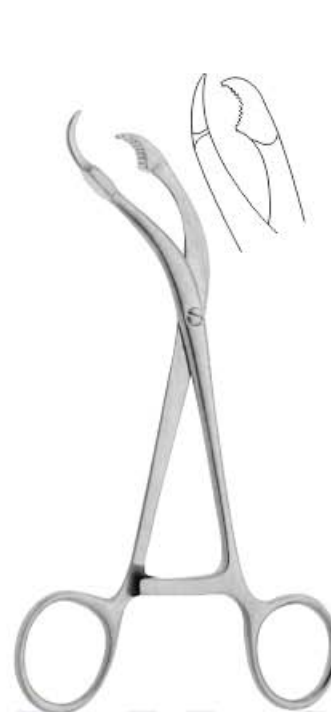

Verbrugge Bone Holding Forceps
09-1221-18 18 cm



Verbrugge Bone Holding Forceps
09-1222-25 25 cm
09-1223-26 26 cm
09-1224-27 27 cm



Verbrugge Bone Holding Forceps



09-1225-05
17.5 cm
5.0mm

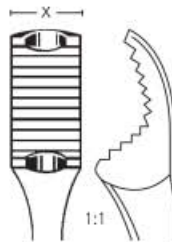

09-1226-09
25 cm
9.5mm

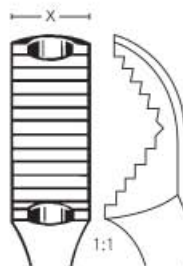

09-1227-10
26 cm
10.5mm

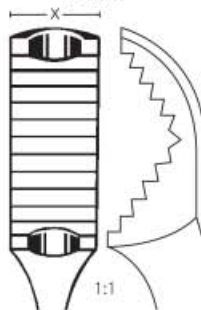

09-1228-12
27 cm
12mm



Verbrugge Bone Holding Forceps
09-1229-18 18 cm



Pelvic Reposition Forceps
09-1230-19 19 cm
09-1231-23 23 cm



Pelvic Reposition Forceps
09-1232-25 25 cm



Pelvic Reposition Forceps
09-1233-25 25 cm
3 Balls Spikes



Pelvic Reposition Forceps
09-1234-40 40 cm

C O R P O R A T I O N



Pelvic Reposition Forceps
09-1235-40 40 cm



Pelvic Reduction Forceps Asymmetric
09-1236-25 25 cm
with 3 ball Spikes



Pelvic Reduction Forceps Asymmetric
09-1237-25 25 cm



Pelvic Reduction Forceps Asymmetric
09-1238-40 40 cm



09-1239-16
Forceps with
thread fixation
16cm

09-1240-22
Forceps with
thread fixation
22cm

Patella Malleolar Forceps
09-1241-21 21 cm

Reduction Forceps
09-1242-16 16 cm
09-1243-24 24 cm
with Thread Lock

Reposition Forceps
09-1244-23 23 cm



Pelvic Reposition Forceps
19 cm
09-1245-01 3,5 mm for Screws
09-1246-02 4,5 mm for Screws



Bone Holding Forceps
09-1247-01



Lane Bone Holding Forceps
09-1248-31 31.5 cm
09-1249-39 39 cm



Subacromion Spreader
09-1250-01 27cm Right
09-1251-02 27cm Left

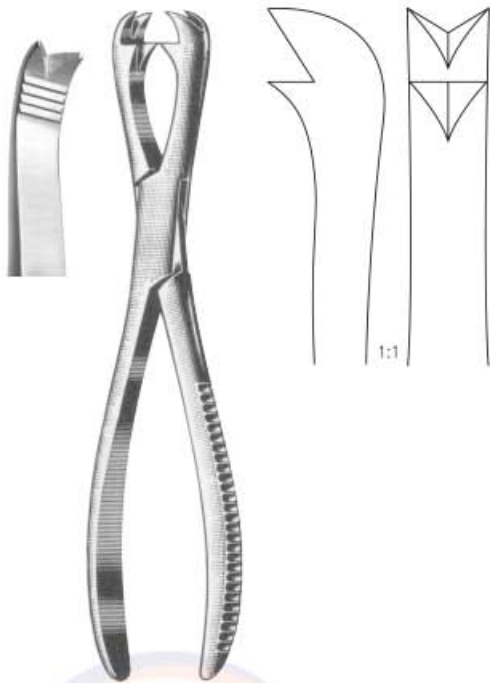

Fergusson Bone Holding Forceps
09-1252-21 21 cm
2 x 2 teeth



Van Buren Sequestrum Forceps
09-1253-23 23 cm
Curved on side, serrated



Langenbeck Bone Holding Forceps
09-1254-21 21 cm

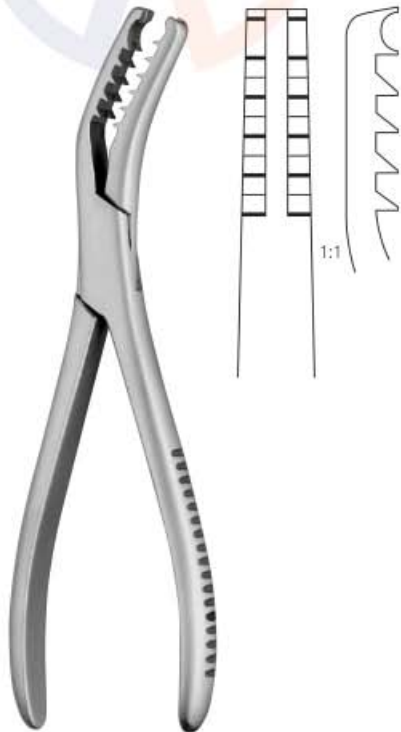

Semb Bone Holding Forceps
09-1255-19 19 cm without ratchet
curved sideways deep teeth



Semb Bone Holding Forceps
09-1256-20 20.3cm with ratchet
curved sideways deep teeth



Sequestrum (Nircosis) Bone Holding Forceps

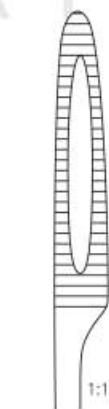

09-1257-18 18 cm
09-1258-20 20 cm
09-1259-23 23 cm
straight

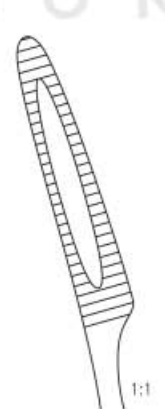

09-1260-18 18 cm
09-1261-20 20 cm
09-1262-23 23 cm
angled on flat

BONE HOLDING FORCEPS

Knochenhaltezaugen
Daviers porte-so

Pinzas para huesos
Tenaglie per ossa

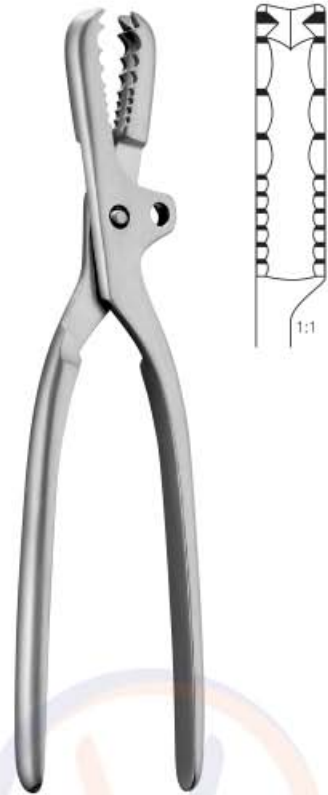

Farabeuf Bone Holding Forceps
09-1263-23 23 cm
09-1264-26 26 cm
with adjustable jaw



Farabeuf-Lambotte Bone Holding Forceps
09-1265-26 26 cm
with adjustable jaw

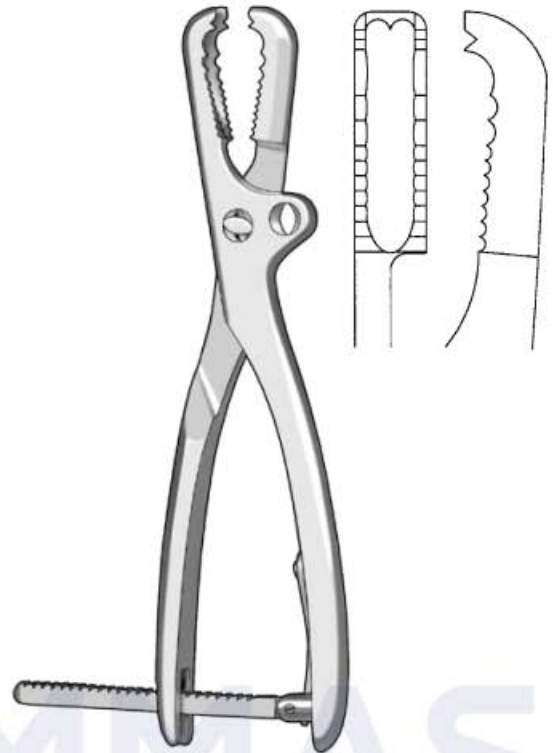

Farabeuf-Lambotte Bone Holding Forceps
09-1266-26 26 cm
with adjustable jaw



Bishop Bone Clamp
09-1267-22 22.5cm
Straight



Kern Bone Holding Forceps
09-1268-17 17 cm
09-1269-24 24 cm
without ratchet



Kern Bone Holding Forceps
09-1270-17 17 cm
09-1271-24 24 cm
with ratchet



Hey Groves Bone Holding Forceps

- 09-1272-21 21 cm
- 09-1273-27 27 cm
- 09-1274-30 30 cm



Lane Bone Holding Forceps

- 09-1275-01 33 cm 11 mm tip
- 09-1276-02 33 cm 13 mm tip
- 09-1277-03 43 cm 13.5 mm tip with Ratchet



Lane Bone Holding Forceps

- 09-1278-01 33 cm 10 mm tip
- 09-1279-02 33 cm 13 mm tip
- 09-1280-03 43 cm 12 mm tip without ratchet



Lambotte Bone Holding Forceps

- 09-1281-22 22 cm
- 09-1282-27 27 cm
- 09-1283-30 30 cm
- One Jaw Mobile adjustable jaw



Lambotte Bone Holding Forceps
Self-Centering, with speed lock



09-1284-15
15 cm
2.5mm

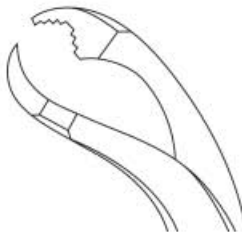

09-1285-19
19 cm
6.5mm

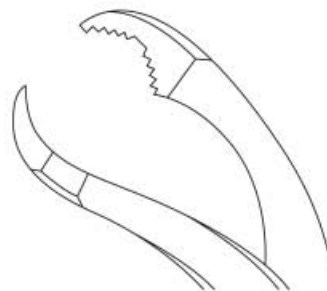

09-1286-24
24 cm
9.5mm

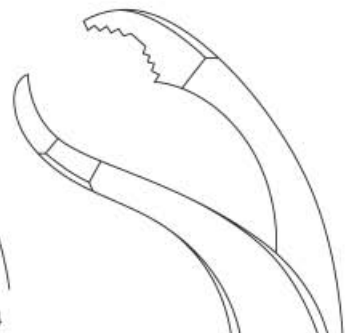

09-1287-26
26 cm
10mm

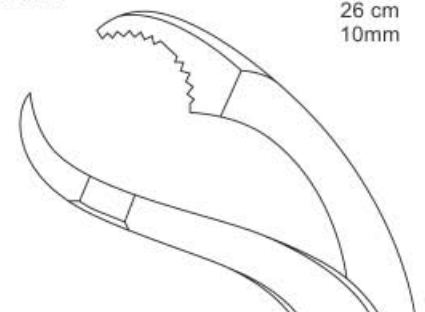

09-1288-28
28 cm
11mm



Maulteil beweglich
movable jaw



LAMBOTTE
09-1289-22 - 09-1291-33



jaw adjustable



09-1292-22
22cm
adjustable

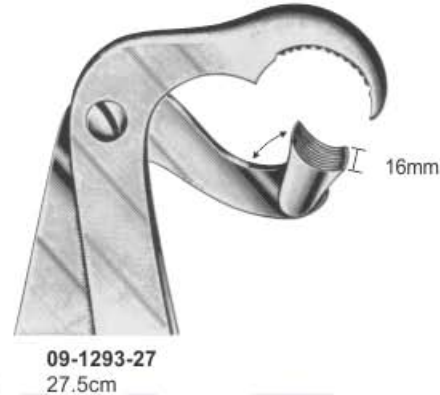

Ulrich Bone Holding
Forceps

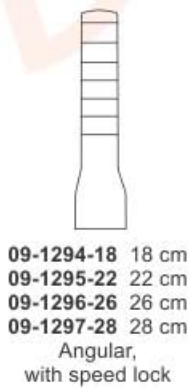

09-1298-23 23cm
09-1299-25 25cm
09-1300-28 28cm
Ulrich Bone Holding forceps
straight



09-1301-23 23cm
09-1302-25 25cm
09-1303-28 28cm
Ulrich Bone Holding Forceps
angled to side

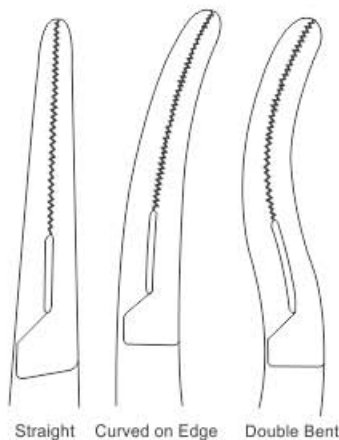

Straight Curved on Edge Double Bent



Collin Bone Holding Forceps
09-1307-19 19 cm
Lion Jaw

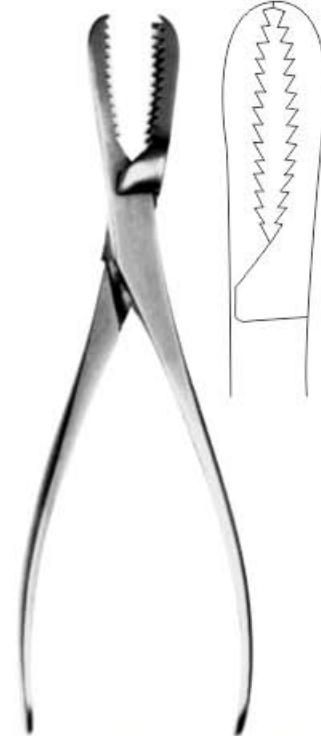

Collin Bone Holding Forceps
09-1308-19 19.5 cm
Toothed Jaw

Collin Bone Holding Forceps
20 cm
09-1304-01 Straight
09-1305-02 Curved on Edge
09-1306-03 Double Bent

KUMMAS
CORPORATION



09-1309-01
Set includes:
Hooked Jaws: 1 pair
Serrated Jaws: 3 pairs
Sizes: 32, 51 and 57 mm



Charnley's Bone Holding Forceps
09-1310-00
With One Pair Hooked Jaws
Three Pairs Serrated Jaws



Kirschner Wires
09-1311-17 17 cm
For fingers, with drill
Guide up to 1 mm



Wire Forceps
09-1312-17 17 cm
Straight, serrated 5.4 mm tip



Lowmann Bone Clamp
09-1313-14 14cm
09-1314-18 18cm 28mm
09-1315-20 20cm 35mm
09-1316-22 22cm 40mm
1x2 Jaws



LOWMAN-GERSTER
09-1317-20 20cm



LOWMAN-HOGLUND
09-1318-19 19cm

KUMMAS
CORPORATION

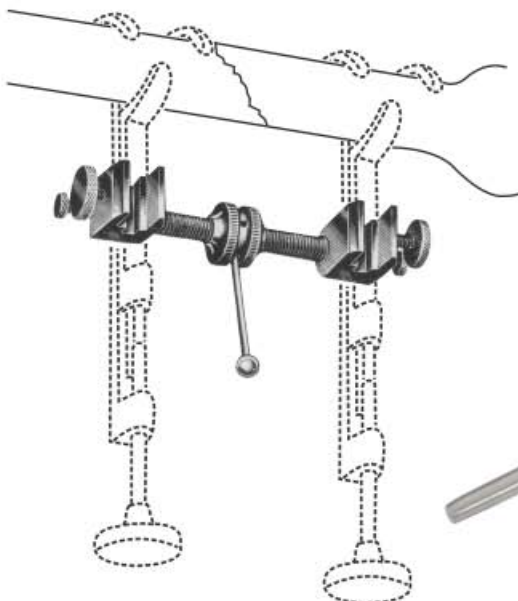

Gerster Bone Holding Clamp
09-1319-15 15cm



Gerster Bone Holding Clamp
09-1320-02



Parham-Martin Bone Clamp
09-1321-21
21cm
Straight



Parham Martin Bands
09-1322-19
19cm

BONE RONGEURS

Hohlmeißelzangen
Pinzas gubias

Pincès-gouges
Pinze-sgorbie

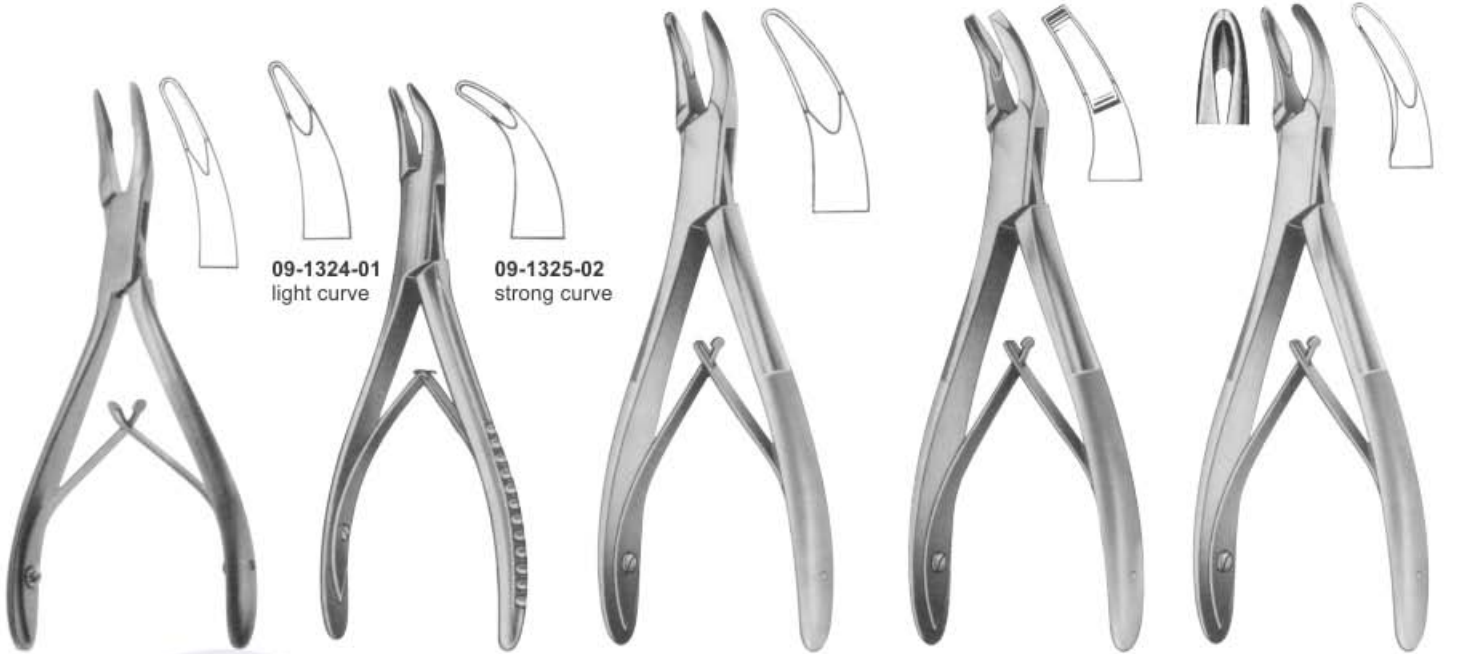

09-1324-01
light curve

09-1325-02
strong curve

Friedmann
09-1323-14
14cm

Rongeurs Delicate
14cm
Jaws 2mm wide

Mead
09-1326-14 #1 - 14cm
09-1327-17 #1A - 17cm

Mead
09-1328-17
#2A, 17cm

Mead
09-1329-14 #4 - 14cm
09-1330-17 #4A - 17cm

KUMMAS
CORPORATION

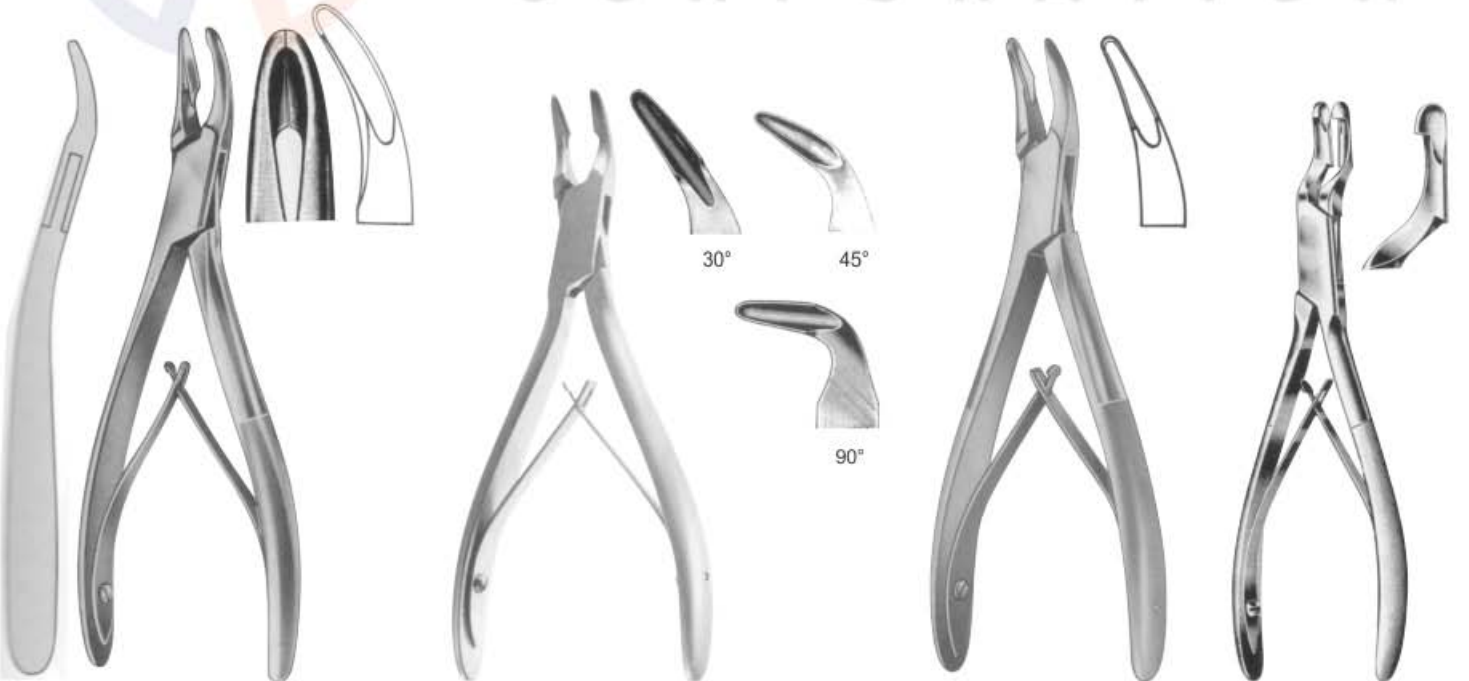

SHELL
09-1331-17
17cm

Blumenthal
09-1332-30
09-1333-45
09-1334-90
16cm

Hartmann
09-1335-16
16cm

Cohen
09-1336-14
14cm

BONE RONGEURS

Hohlmeißelzangen
Pinzas gubias

Pincès-gouges
Pinze-sgorbie



BONE RONGEURS

Hohlmeißelzangen
Pinzas gubias

Pinces-gouges
Pinze-sgorbie

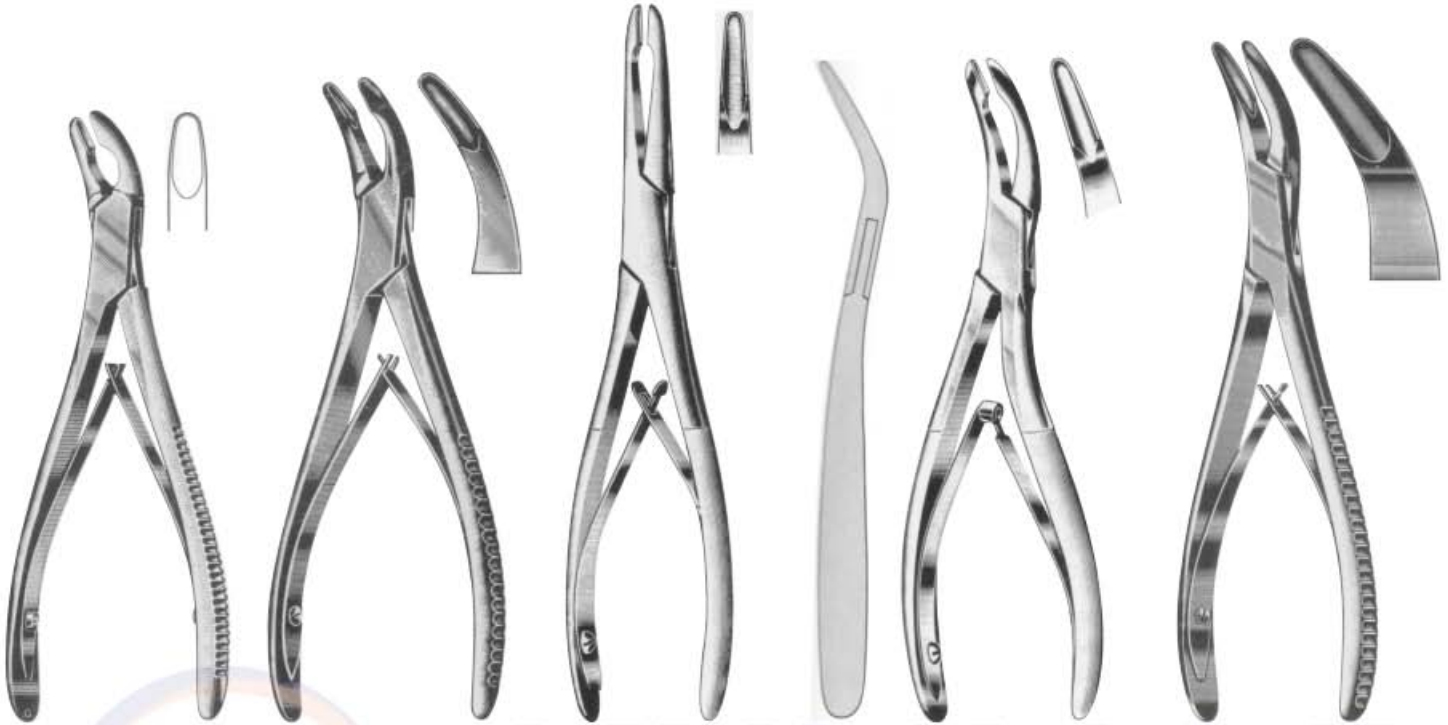

HAKANSSON
09-1349-15
15.5cm

BANE-HARTMANN
09-1350-17
17.5cm

Defourmentel Rongeurs
09-1351-19
slender beaks, straight,
jaws 3mm wide,
19cm

Cottle-Jansen Rongeurs
09-1352-18
S-shaped, jaws 4mm wide,
18cm

Olivecrona
09-1353-20
20cm

C O R P O R A T I O N



09-1354-01
slightly
curved

09-1355-02
fully
curved

09-1356-01
slightly
curved

09-1357-02
fully
curved

09-1358-01
right hand
8mm

Kleinert-kutz Synovectomy
Rongeurs jaws 2mm wide
14cm

STELLBRINK Synovectomy
Rongeurs jaws 2mm wide
17cm

Fisch
17cm

09-1359-02
left hand
8mm



09-1360-17
Straight

09-1361-17
Curved

LUER
17cm



LUER
09-1362-18
18.5cm



LUER
09-1363-18
18cm



Adson Cranial Rongeur,
09-1364-21
straight, jaws 8mm wide,
21cm



GULEKE
09-1365-22
22cm



BACON CRANIAL RONGEUR,
09-1366-20
Angled, jaws 7mm wide,
20cm



09-1367-15
15cm
Straight



09-1368-15
15cm
Curved



09-1369-15
2 x 13 mm

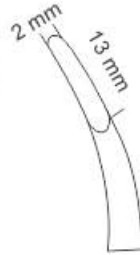

09-1370-02
2mm



09-1371-03
3mm

Bohler Bone Rongeur

Kleinert-Kutz Bone Rongeur
15 cm

Ruskin-Mini Bone Rongeur
15cm Curved

KUMMAS
CORPORATION

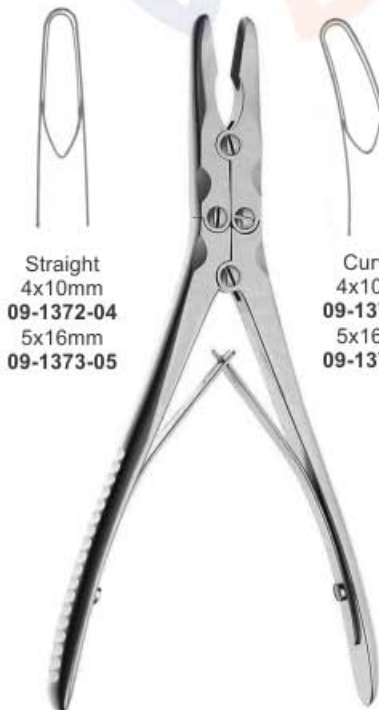

Straight
4x10mm
09-1372-04
5x16mm
09-1373-05



Curved
4x10mm
09-1374-04
5x16mm
09-1375-05



09-1376-24
Straight,
5 x 16mm



09-1377-24
Curved
5 x 16mm



Beyer Bone Rongeur
18cm
09-1378-03 3 x 14mm
09-1379-04 4 x 15mm
Double action, Curved

Ruskin Bone Rongeur
18cm

Ruskin Bone Rongeur
24cm

BONE RONGEURS

Hohlmeißelzangen
Pinzas gubias

Pinces-gouges
Pinze-sgorbie



Zaufal-Jansen Bone Rongeur
09-1380-18 18cm
Double action
Curved, 5x15mm



Marquardt Bone Rongeur
09-1381-18 18cm



Mayfield Bone Rongeur
09-1382-18 18cm

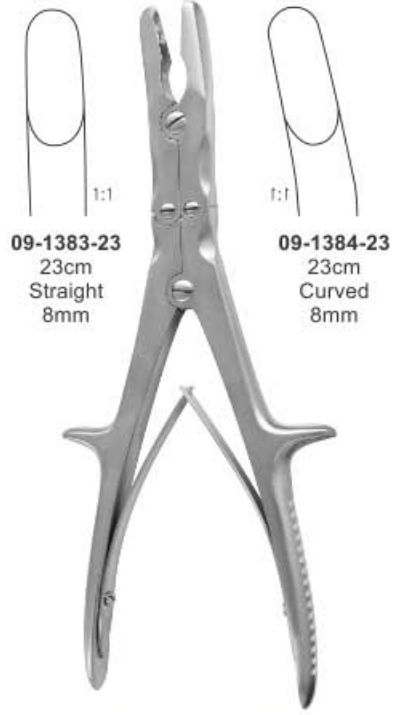

09-1383-23
23cm
Straight
8mm

09-1384-23
23cm
Curved
8mm

Stille-Ruskin Bone Rongeur



Smith-Peterson Laminectomy Rongeur
09-1385-24 24cm
Double action,
straight 3 x 16mm



Smith-Peterson Laminectomy Rongeur
09-1386-24 24cm
Double action
slightly curved 3 x 16mm



Smith-Peterson Laminectomy Rongeur
09-1387-24 24cm
Double action
fully curved 3 x 16mm

BONE RONGEURS

Hohlmeißelzangen
Pinzas gubias

Pinces-gouges
Pinze-sgorbie

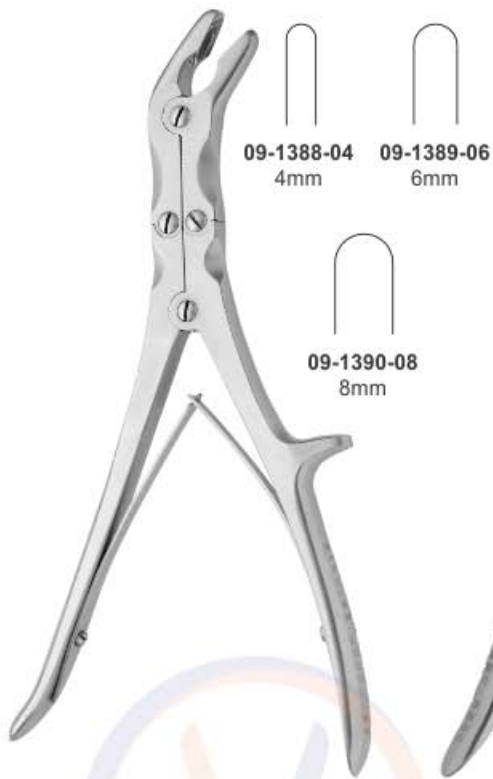

Stille Bone Rongeur
23cm



Leksell Bone Rongeur
24cm
Double action, fully curved



Echlin Duckbill Bone Rongeur
23cm

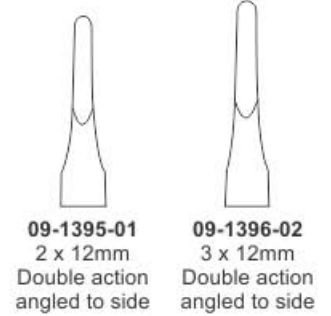

Stille-Luer Rongeur Forceps
23cm

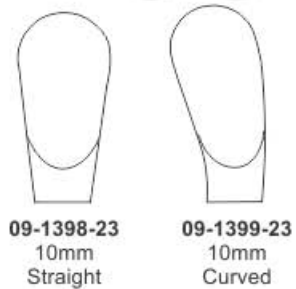

Luer-Stille Bone Rongeur
27 cm

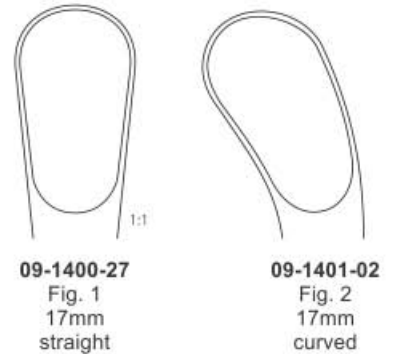

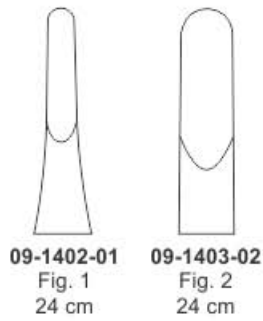

Leksell-Stille Bone Rongeur

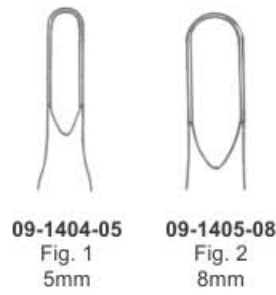

Leksell Bone Rongeur
23cm



Hakansson Bone Rongeur
09-1406-20 20cm



Stille-Luer Echlin Duckbill Rongeur
23cm
09-1407-01 6 x 13mm
09-1408-02 6 x 15mm
Double action angled to side



Stille-Luer Rongeur
09-1409-21 21.5cm
Double action angled to side
10 x 16mm



Sybert Rongeur
09-1410-01 35cm 4 x 16mm
09-1411-02 35cm 8 x 16mm
09-1412-03 35cm 12 x 16mm
09-1413-04 37cm 5 x 16mm
Double action, Angled

BONE RONGEURS

Hohlmeißelzangen
Pinzas gubias

Pinces-gouges
Pinze-sgorbie



Rottgen-Ruskin Bone Rongeur
09-1414-23 23cm

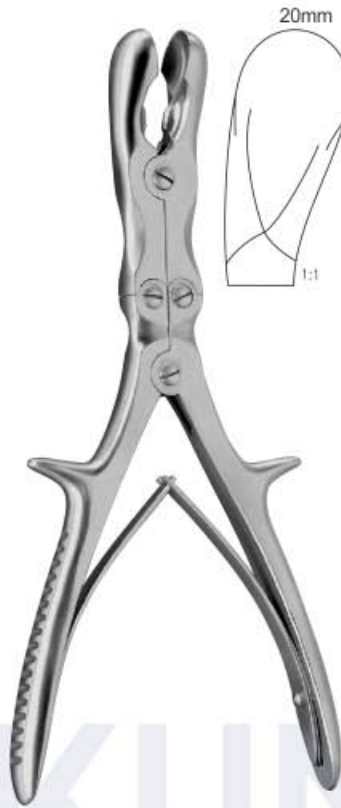

Semb Bone Rongeur
09-1415-24 24cm



Frykholm Bone Rongeur
09-1416-24 24cm

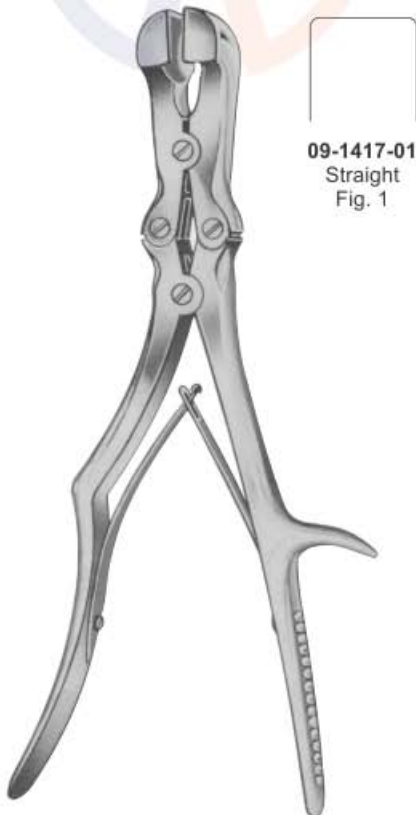

Sauerbruch Bone Rongeur
30 cm



09-1417-01
Straight
Fig. 1

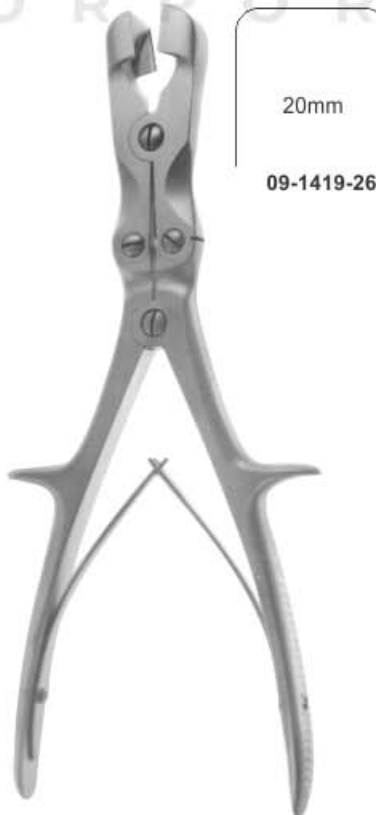

Sauerbruch-Stille
26cm

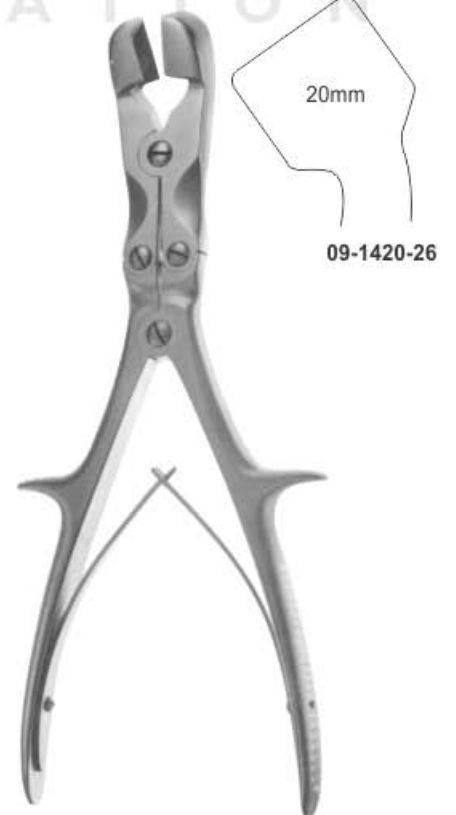

Sauerbruch-Stille
26cm

BONE CUTTING FORCEPS

Knochensplitterzangen | Pinzas cortantes para huesos
 Pincas coupantes a os | Cesioie per ossa



09-1421-15
15 cm
Straight



4mm
09-1422-04
6mm
09-1423-06



09-1424-20



Cottle-Kazanjian Bone
Cutting Rongeur Forceps
09-1425-19 19 cm

Littauer / Liston Bone
Cutting Rongeur Forceps

Cleveland Gardner Bone Cutting
Forceps
16cm

Markwalder Bone Cutting
Forceps
20cm

KUMMAS CORPORATION



09-1426-15
15 cm
curved



09-1427-17
17 cm
curved



09-1428-14 14 cm
09-1429-17 17 cm
09-1430-19 19 cm
09-1431-20 20 cm
09-1432-22 22 cm
Straight



09-1433-14 14 cm
09-1434-17 17 cm
09-1435-19 19 cm
09-1436-22 22 cm
Angled

Cleveland Bone Cutting
Rongeur Forceps

Liston Bone Cutting
Rongeur Forceps

Liston Bone Cutting
Rongeur Forceps

BONE CUTTING FORCEPS

Knochensplitterzangen
Pinces coupantes a os

Pinzas cortantes para huesos
Cesoie per ossa

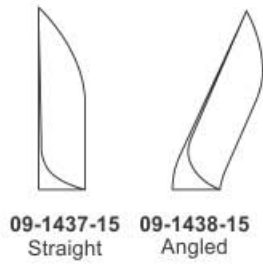

Bohler Bone Cutting Forceps
15cm

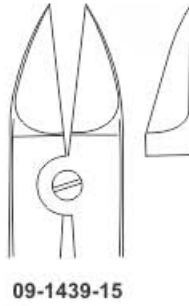

Bone Cutting Forceps
15 cm

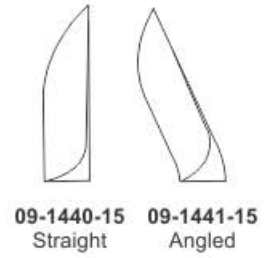

Walton-Liston Bone Cutting Rongeur Forceps
15cm



Liston-mini
09-1442-15
15cm



Liston-mini
09-1443-15
15cm



Kleinert-Kutz
09-1444-15
15cm

BONE CUTTING FORCEPS

Knochensplitterzangen

Pinzas cortantes para huesos

Pinces coupantes a os

Cesoie per ossa

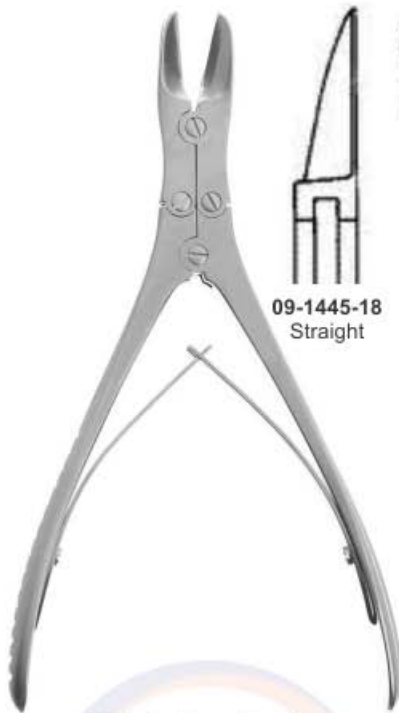

09-1445-18
Straight

09-1446-18
Angled

Mc Indoe Bone Cutting
Rongeur Forceps
18cm

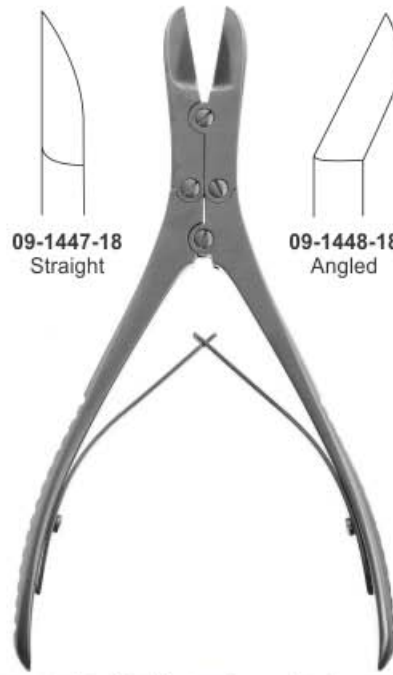

09-1447-18
Straight

09-1448-18
Angled

Ruskin-Liston Bone Cutting
Forceps
18.5cm



Ruskin Bone Cutting
Rongeur Forceps
09-1449-20 20 cm



LISTON
09-1450-23
curved on flat
23.5cm



LISTON
09-1451-28
straight
28cm



LISTON
09-1452-27
curved on flat
27.5cm

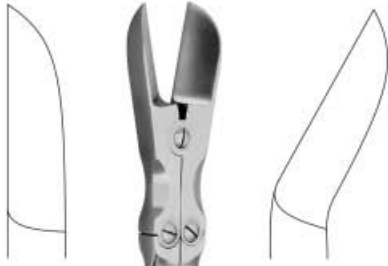

09-1453-27
27 cm
Straight

09-1454-27
27 cm
Angled 45°



Stille-Liston Bone Cutting Forceps



09-1455-27
27 cm
Straight

Stille-Liston Bone Cutting Rongeur Forceps



Stille-Horsley Bone Cutting Forceps
09-1456-24 24 cm



Horsley Bone Cutting Rongeur Forceps
09-1457-25 25 cm



Semb Bone Cutting Rongeur Forceps
09-1458-24 24 cm



Delicate Wire Cutter
09-1459-12 12.5cm
Side cutting w/ carbide inserts
max capacity. 0.7mm 028"



Wire Cutter
09-1460-15 15cm
for hard wires up to 1mm,
for soft wires up to 1.5mm
tungsten carbide inserts



Side Cutter
09-1461-18 18.5cm
Carbide jaws
max capacity. 1.6mm 062"



Wire Cutter
09-1462-14 14.5cm
for hard wires up to 1mm,
for soft wires up to 1mm
tungsten carbide inserts



Side Wire Cutter
09-1463-18 18cm
for hard wires up to 1.5mm,
for soft wires up to 2mm
09-1464-22 22cm
for hard wires up to 2.2mm,
for soft wires up to 2.8mm
tungsten carbide inserts



Side Wire Cutter angled
09-1465-22 22cm
for hard wires up to 2.2mm,
for soft wires up to 2.8mm
tungsten carbide inserts



S Line side Wire Cutter
09-1466-23 23cm
for hard wires up to 2.2mm,
for soft wires up to 3mm
tungsten carbide inserts



Front And Side Wire Cutter
09-1467-18 18cm
for hard wires up to 1.7mm,
for soft wires up to 2mm
tungsten carbide inserts



Wire Cutter
09-1468-17 17cm
carbide inserts,
double action. Max capacity. 1.6mm 062"

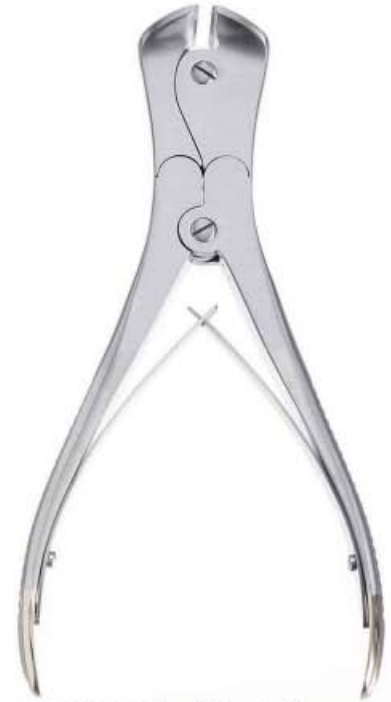

S Line Front Wire Cutter
09-1469-22 22cm
for hard wires up to 2.2mm,
for soft wires up to 3mm
tungsten carbide inserts



Hard Wire Cutter Cuts
09-1470-26 26cm
for hard wires up to 3mm



Cannulated Wire / Pin Cutter
09-1471-19 19 cm
Cuttis wire upto 1.6 mm



Plate Cutting Forceps
Up To 1mm
09-1472-24 24 cm Straight



Hand-Held Rod Cutter
09-1473-00 Straight,
Cuts rods
4.76mm to 6.35mm



Table Top Rod Cutter
09-1474-00 70cm
Cuts rods from:
4.76mm to 6.35mm



Front Pin Cutter Small
09-1475-26 26cm
Max cap: 3.2mm



Front Pin Cutter Medium
09-1476-36 36.5cm
Max cap: 4.7mm



Side Pin Cutter Large
09-1477-57 57.5cm
Side cutting,
Max. capacity 4.0mm



Side Pin Cutter Large
09-1478-57 57.5cm
Side cutting w/ **carbide inserts**
Max. capacity 6.3mm



Bunnell Drill
09-1479-00 16cm
Opening up to 4mm
09-1480-01 spare key
light metal housing
longitudinally cannulated

KUMMAS
CORPORATION



Ralk Drill
09-1481-00 16cm
Opening up to 6.35mm
light metal housing
longitudinally cannulated

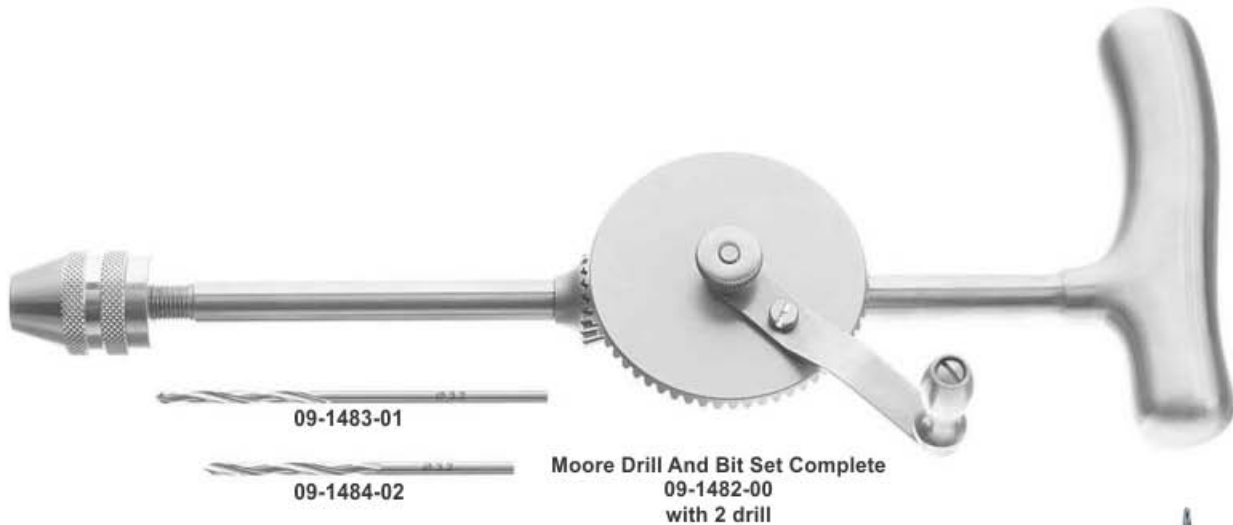

Stille Hand Drill
09-1485-00 20cm
Complete with 9 twist drills
(Fig. 1 to Fig. 9)
09-1486-50
Complete with 12 twist drills
(Fig. 000 to Fig. 9)



HUDSON
09-1499-00 8 burs **09-1507-01 to 09-1514-08**
09-1500-10 28cm
 Hand drill, complete set, with improved snap lock chuck and 4 burs **09-1507-01 to 09-1510-04**

09-1501-01
Brace Only

09-1502-02
Drill Chuck Only



HUDSON
09-1503-00 8 burs **09-1507-01 to 09-1514-08**
09-1504-10 27cm
 Hand drill, complete set, consisting of trepanning brace, cerebellar attachment and 4 burs **09-1507-01 to 09-1510-04**

09-1505-01
Brace Only

09-1506-02
Cerebellar attachment only



Huson Hand drill bit
Fig.1
09-1507-01
9mm



Huson Hand drill bit
Fig.2
09-1508-02
14mm



Huson Hand drill bit
Fig.3
09-1509-03
16mm



Huson Hand drill bit
Fig.4
09-1510-04
22mm



ADSON
09-1511-05
Ø 15mm



McKenzie
Hand drill bit
09-1512-06
13mm



Cushing
Hand drill bit
09-1513-07
14mm



Ø 2mm
09-1514-08



Hand Drill
09-1515-00
opening up
to 6.35mm

Jacob's Chuck
09-1516-00 T-Handle and key
09-1517-01 only
09-1518-02 Key

T-Handle
09-1519-00
AO Coupling

T-Handle
09-1520-00
for AO Coupling

Jacobs
09-1521-00 28cm
opening up to 6.35mm



Key Handle
09-1522-01



Memoral Head Extractor
09-1523-01



Fiber Handle
09-1524-01
for AO coupling



Plastic Handle
09-1525-01
AO Coupling



**Dental
Handle Coupling**
09-1526-01



Fiber Handle
09-1527-01
AO Coupling



Fiber Key Handle
09-1528-01
18cm

KUMMAS
CORPORATION



Countersink
09-1529-01

Countersink
09-1530-01

Countersink
09-1531-01

Milling Cutter Countersink
with cross handle
09-1532-01 2.0 mm
09-1533-02 3.2 mm
09-1534-03 4.5 mm
09-1535-04 6.5 mm
17cm

Mini Countersink
09-1536-01
1.5 mm Screws
2.00 mm Diam
Tip 1.1 mm

Small Countersink
09-1537-01
2.7, 3.5 mm and
4.0 mm Screws
Tip 2.0 mm

Malleolar
Countersink
09-1538-01
Tip 3.2 mm

Tap, with cross-handle
09-1539-25 Ø2.5mm, 14cm
09-1540-27 Ø2.7mm, 14cm
09-1541-30 Ø3.0mm, 16cm
09-1542-35 Ø3.5mm, 16cm
09-1543-36 Ø3.6mm, 16cm
09-1544-40 Ø4.0mm, 18cm
09-1545-45 Ø4.5mm, 18cm
09-1546-65 Ø6.5mm, 22cm

NEEDLES, AWL & BONE HOOKS

Nadeln, Ahle & Knochenhaken

Agujas, Punzones y Ganchos para Hueso

Aiguilles, poinçons et crochets en os

Aghi, punteruolo e ganci per osso



Obwegeser Needle
09-1547-14
14 cm



Obwegeser Needle
09-1548-18 18 cm



Obwegeser Needle
09-1549-23 23 cm



Shoulder Percussion Awl
Pointed, 21.6cm
09-1550-21 Small
09-1551-23 Pointed, 23.5cm



09-1552-14
14cm



Perthes
09-1553-18 18cm
09-1554-21 21cm



09-1555-14
14cm



Sharp Bone Hook
09-1556-23
23cm



Sharp Bone Hook
09-1557-23
23cm



Sharp Bone Hook
09-1558-23
23cm



HEXAGONAL HEAD

	Size of screws	Head Size
09-1559-01	1.5mm	1.5mm
09-1560-01	2.0mm	
09-1561-01	2.7mm	2.5mm
09-1562-01	3.5mm	
09-1563-01	4.0mm	
09-1564-01	4.5mm	3.5mm
09-1565-01	6.5mm	



Screw Driver
09-1566-01
single head



Screw Driver
09-1567-01
philips head



Screw Driver
09-1568-01
slotted head



Screw Driver
09-1569-01



Williams
Screw Driver
24cm



09-1570-01
Phillips Head



09-1571-02
Slotted Head



09-1572-03
Single Head



09-1573-04
Hexagonal Head
3.5 mm



Holding Sleeve
09-1574-05 1.5 mm



Holding Sleeve
09-1575-06 2.5 mm



Parallel Target Device
09-1576-01
for guide wires 2mm



Mortising Chisel
09-1577-01



Wire Guide
09-1578-45
45mm



Wire Guide
09-1579-70
70mm



Drill Small Pointed
09-1580-01
Drill Bit 3.5 mm



Drill Pointed Guide
09-1581-01
6.5 mm



Insert Drill Sleeve
09-1583-01
2.7 / 2.0 mm Drill Bit 2.0 mm
09-1584-02
3.5 / 2.5 mm Drill Bit 2.5 mm
09-1585-03
4.5 / 3.2 mm Drill Bit 3.2 mm



Drill Pointed Guide
09-1582-01
6.5 mm



C-Clamp
09-1586-01
Drill Guide with thread
for Drill Bit 4.5 mm



Drill Guide
09-1587-01
4.5 mm Screws
Drill Bit 4.5 mm &
3.2 mm



Drill Guide
09-1588-01
6.5 mm Screws
Drill Bit 3.2 mm



Drill Guide
09-1589-01
3.5 mm for neutral
and compression Positioning
Drill Bit 2.5 mm



Mini Drill Sleeve
09-1590-01
 1.1 mm and 1.5 mm drill bits
09-1591-02
 1.5 mm and 2.0 mm drill bits



Drill Guide
09-1592-01
 drill sleeve for 2.0 mm
 drill bit



09-1593-01 Tap Sleeve, 2.0 mm ϕ
09-1594-02 Drill Sleeve, 2.7 mm ϕ
09-1595-03 Tap Sleeve, 2.5 mm ϕ
09-1596-04 Drill Sleeve, 3.5 mm ϕ



Neutral & Load Drill Guide
09-1597-01 1.5 mm for 2.0 mm Screws
09-1598-02 2.0 mm for 2.7 mm Screws
09-1599-03 2.5 mm for 3.5 mm Screws
09-1600-04 3.2 mm for 4.5 mm Screws

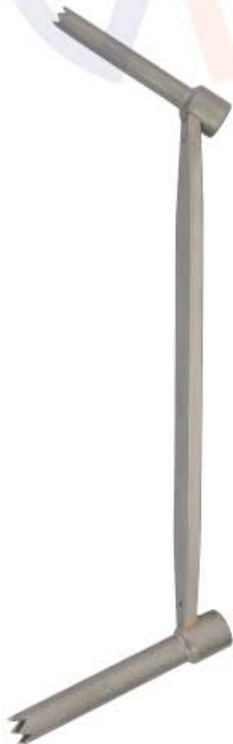

Tap Sleeve
09-1601-01
 3.5 mm



Tap Sleeve
09-1602-01
 3.5 mm also for used
 as 3.2 mm drill Guide



Tap Sleeve
09-1603-01
 4.5 mm



Drill Sleeve
09-1604-01
 3.2 mm for Round
 Hole Plates

INSTRUMENTS FOR SCREW DRILL

Instrumente für Schraubenbohrer | Instrumentos para taladro de tornillo
 Instruments pour perceuse à vis | Strumenti per trapano a vite



Lane Screw Holding Forceps
 09-1605-23 23cm



Screw Forceps
 09-1606-01



Sharp Hook
 16.5 cm
 09-1607-01



Bending Template

Size	3.5 mm	4.5 mm
5 hole		09-1610-03
7 hole	09-1608-01	09-1611-04
9 hole	09-1609-02	09-1612-05



Combination Wrench
 09-1613-01
 width across flats
 11 mm



Socket Wrench
 09-1614-01
 width across flats 11 mm



Compression Device
 09-1615-01
 8 mm screw-type



Articulated Tension Device
 09-1616-01
 with Indicator span 20 mm may
 also be used for distraction
 of standard and small plates



Pin Wrench
 09-1617-01
 Tension Device
 & Distactor



Drill Sleeve
 09-1618-01
 Tension Device



Demel
28 cm

- 09-1619-32 32 mm
- 09-1620-45 45 mm
- 09-1621-62 62 mm



Demel
09-1622-28
28 cm



Cerclage Wire Twister
09-1623-12 12.5cm
stainless



Wire Tightener
09-1624-12 12.5cm
stainless



Loute
09-1625-21
21.5cm



- Bone Wire**
- 09-1626-01 0.2mm
 - 09-1627-02 0.3mm
 - 09-1628-03 0.4mm
 - 09-1629-04 0.5mm
 - 09-1630-05 0.6mm
 - 09-1631-06 0.7mm
 - 09-1632-07 0.8mm
 - 09-1633-08 0.9mm
 - 09-1634-09 1.0mm
 - 09-1635-10 1.2mm
 - 09-1636-11 1.5mm
- bone wire, soft,
in coils of 10m



- Bone Wire**
- 09-1637-01 0.8mm x 280mm
 - 09-1638-02 1.0mm x 280mm
 - 09-1639-03 1.2mm x 280mm
 - 09-1640-04 1.0mm x 280mm
 - 09-1641-05 1.2mm x 280mm
- bone wire with eye soft
package of 10 pieces



Slotted Nail Driver
09-1642-21
21.5cm



Reamer
09-1643-21
21.5cm



Moore Rasp
09-1644-21
21.5cm
slandered stream



Bending Device
09-1645-00
21.5cm
to bend straight
and angled plates



Bending Device
09-1646-00
21.5cm
to bend straight
and angled plates



Rod Bender
09-1647-01
to bend straight
and angled



Universal Rod Bender
09-1648-01 28.5cm
to bend straight
and angled



Rod Bender
09-1649-01
to bend straight
and angled



Slotted Hammer
09-1650-01 14mm



Jewett
09-1651-20
20cm



Jewett
09-1652-20
20cm

with vertical
borings,
Ø 3.5 - 4.0 -
6.5 - 8.0 mm



09-1653-24
24cm



Lane
09-1654-18
18cm



Plate Bender
09-1655-01



Plate Bender
09-1656-01



Plate Bender
09-1657-01



Plate Bender
09-1658-01



Lane holding forceps
for bone plates
09-1659-22 22cm



Lane Bone
Plate Holding
Forceps
09-1660-22 22cm

EXTENSION BOWS

Extensionsbugel

Estribos para extension

Etriers pour extension

Archi per estensione



09-1661-18 18cm
Wire strainer for
kirschner wires



Kirschner Extension Bows

- 09-1662-01** x=95mm y=70mm
- 09-1663-02** x=100mm y=100mm
- 09-1664-03** x=120mm y=120mm
- 09-1665-04** x=155mm y=155mm
- 09-1666-05** x=200mm y=155mm
with 3 traction hooks



Kirschner Extension Bows

- 09-1667-01** x=130mm
- 09-1668-02** x=185mm
- 09-1669-03** x=220mm
with 3 traction hooks



**Wrench
Kirschner
Extension Bows**
09-1670-01
14mm/17mm



Kirschner Extension Bows

- 09-1671-01** x=180mm y=100mm
- 09-1672-02** x=270mm y=160mm
with 3 traction hooks



Bohler Kirschner Extension Bows

- 09-1673-01** x=75mm y=90mm
- 09-1674-02** x=90mm y=160mm
- 09-1675-03** x=110mm y=210mm
- 09-1676-04** x=150mm y=210mm
with 3 traction hooks



Charnley-mueller

- 09-1677-00**
Compression Clamp



Screw Depth Gauges

- 09-1678-01 Mini Gauge, 4 3/4" Long measures up to 30mm
- 09-1679-02 Small Gauge, 6 1/4" Long measures up to 50mm
- 09-1680-03 Large Gauge, 8 3/4" Long measures up to 100mm
- 09-1681-04 X-Large Gauge, 11" Long measures up to 120mm



Screw Depth Gauges

- 09-1682-01 Mini Gauge, 4 3/4" Long measures up to 30mm
- 09-1683-02 Small Gauge, 6 1/4" Long measures up to 50mm
- 09-1684-03 Large Gauge, 8 3/4" Long measures up to 100mm
- 09-1685-04 X-Large Gauge, 11" Long measures up to 120mm



Screw Depth Gauge

- 09-1686-01 1.5 mm & 2.0 mm screws
- 09-1687-02 2.7 mm & 4.0 mm screws
- 09-1688-03 4.5 mm & 6.5 mm screws



Measuring Gauge
09-1689-01
for nail

09-1690-00 Tri Angular Positioning Plate

